

xylem
Let's Solve Water



McDonnell & Miller® General Catalog

MM-825M



McDonnell & Miller
a xylem brand

HOW TO USE THIS CATALOG

This guide will assist you in your tour of the McDonnell & Miller General Catalog. The information contained in the catalog is organized into 5 key categories:

- System Selection Chart
- Product Selection Guide
- Basic System Operation
- Products
- Technical Information and Specifications

Easy to identify symbols and product icons will help you specify and select the product that meets your requirements.

BASIC SYSTEM OPERATION...

...the encyclopedia of boiler operation. An easy-to-read, informative guide to all the basic elements that make steam and hot water boiler systems work.

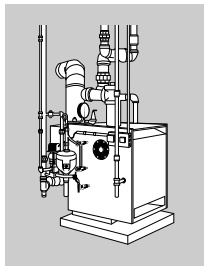

PRODUCTS...

...the complete McDonnell & Miller product line, divided into 3 primary groups:

Boiler Controls

Liquid Level Controls

Flow Switches

Just check the **CONTENTS** pages for the associated product icons to quickly find the control you need.

APPLICATIONS...



Industrial applications



Residential applications



Commercial applications

TECHNICAL INFORMATION AND SPECIFICATIONS...

...full of helpful data to assure your selection is the right one.

Glossary of Terms

... a detailed description of all terms that appear in this catalog.

Approval Agencies

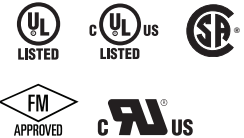

MAINTENANCE & REPLACEMENT INTERVAL GUIDELINES...

...the easy to read guides will help keep you on track with suggested product maintenance and replacement intervals.

Recommended Replacement Intervals

Product	Series	Recommended Maintenance	Recommended Replacement Interval (Maximum)
	150, 157, 158, 159, 150S, 157, 158S, 159S	Blow down and test daily inspect annually.	15 years
	69, 169, 269, 369, 469	Inspect and test annually.	10 years
	67, 767	Blow down weekly. Inspect and test annually.	10 years
Low Water Cut-Offs	61, 63, 64, 764	Blow down weekly. Inspect and test annually.	10 years
	42	Blow down daily. Inspect and test annually.	10 years

Warranty & Return Policy

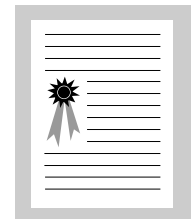









Basic System Operation6
 Products: *Boiler Controls*24
 Liquid Level Controls70
 Flow Switches78





Technical Information and Specifications





Glossary of Terms116
Approval Agencies119
Maintenance120
Warranty & Return Policy123-124

BOILER CONTROLS











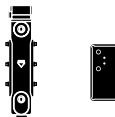











LOW WATER CUT-OFFS	SERIES	PAGE
<i>• For Hot Water Boilers</i>		
Electronic	750 	28
	751P/752P 	29
	RB-24E 	32
	RB-122-E 	33

Float Type	63 	37
	64 	38
	764 	39
	767 	41



LOW WATER CUT-OFFS	SERIES	PAGE
<i>• For Steam Boilers</i>		
Electronic	750 	28
	751P/752P 	29
	PSE-800 	30
	PSE-800-M 	31

Float Type	61 	36
	63 	37
	64 	38
	67 	40
	69 	42

BOILER CONTROLS (continued)

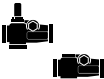

LOW WATER CUT-OFFS	SERIES	PAGE	WATER FEEDERS	SERIES	PAGE	
<ul style="list-style-type: none"> • <i>Combination Low Water Cut-Off/Pump Controllers for Steam Boilers</i> Electronic 	1575	 47	<ul style="list-style-type: none"> • <i>Electric</i> 	WFE	 52	
				<ul style="list-style-type: none"> • <i>Mechanical</i> 	101-A	 53
<ul style="list-style-type: none"> • <i>Combination Low Water Cut-Off/Pump Controllers for Steam Boilers</i> Float Type 	42S	 43	<ul style="list-style-type: none"> • <i>Mechanical</i> Combination Mechanical Low Water Cut-Offs 	47/47-2	 54	
	93	 48		51/51-2	 58	
	94	 50		51-S/51-S-2	 59	
	150S	 44		53/53-2	 60	
	157S	 45		247/247-2	 56	
	193	 49		<ul style="list-style-type: none"> • <i>Make-Up</i> 	21	 63
	194	 51			25-A	 62
					221	 63
			551-S	 66		
			847	 64		
			851	 65		
			851-S	 65		

BOILER CONTROLS (continued)

<u>VALVES</u>	<u>SERIES</u>		<u>PAGE</u>
• <i>Blow Down</i>	14-B		67
• <i>Test-N-Check®</i>	TC-4		67
• <i>Pressure Relief</i>	250		68
	260		68

LIQUID LEVEL CONTROLS

CONDUCTANCE ACTUATED (PROBE TYPE)

• <i>General Purpose Sensors and Controls</i>	RS Sensors		72
	750B-C3		74
	PA Sensors		75

















FLOAT ACTUATED PNEUMATIC

PFC		77
-----	---	----

FLOAT ACTUATED VALVES

27-W		76
------	---	----

FLOW SWITCHES

<u>LIQUID FLOW</u>	<u>SERIES</u>	<u>PAGE</u>	<u>AIR FLOW</u>	<u>SERIES</u>	<u>PAGE</u>	
• <i>General Purpose</i>	FS4-3		86	AF1		110
	FS4-3T		104	AFE-1		111
	FS5		99	AF2		112
	FS8-W		88	AF3		113
	FS-250		90			
						
• <i>High Sensitivity</i>	FS1		100			
	FS1-W		101			
	FS6		102			
	FS6-W		102			
• <i>Industrial</i>	FS7-4		92			
	FS7-4E		94			
	FS7-4W		96			

Steam Boilers

They've been with us for over two hundred years, and most of the time, they're so reliable most folks don't give them much thought. They sit in buildings all over the world, transferring heat from fuel to water, allowing us to warm our buildings or complete our processes.

Steam boilers are simple, efficient and reliable. No machine does a better job of moving BTUs from one place to another. We've used them for space heating since before the United States Civil War in 1861.

Even before the Civil War, we used steam boilers for industrial processes. Today we use them to run factories, press clothes, wash dishes, pasteurize milk, sterilize medical equipment, and to heat entire cities! Their capabilities seem endless.

But despite its simplicity, any steam boiler can run into trouble if its control system doesn't act properly. If the energy you put into the boiler exceeds what the boiler can absorb, the boiler can rupture. So you must always be on guard.

A simple safety relief valve of the right capacity and relief-pressure setting protects the boiler from over pressure. But over pressure isn't the only thing that can threaten a steam boiler. There are also the dangers of dry firing.

Should the internal water level drop too low, the boiler can burn out. So here too, you must always be on guard. You see, a steam boiler needs its water to move the heat away from its metal surfaces. Without the right internal level of water, heat quickly accumulates. Too much heat creates a very dangerous operating condition.

Boiler manufacturers have always set up minimum safe water level requirements for their equipment. Our controls help enforce those requirements in two ways:

- By maintaining a minimum safe water level in the boiler.
- By signaling the burner to stop should the water level drop below that point.

In this brief Systems Guide we will explain how we do these two very important jobs.

What's a "Normal" Water Level?

The proper steam boiler water level varies from manufacturer to manufacturer, but generally, we can say that it's "normal" to start by manually filling the boiler to the two-thirds-full point on the gauge glass. As the boiler operates, the water will quickly turn to steam and head out toward the system (Fig. B).

Steaming takes place at a constant rate of about one-half gpm per 240,000 BTU/HR (D.O.E. Heating Capacity

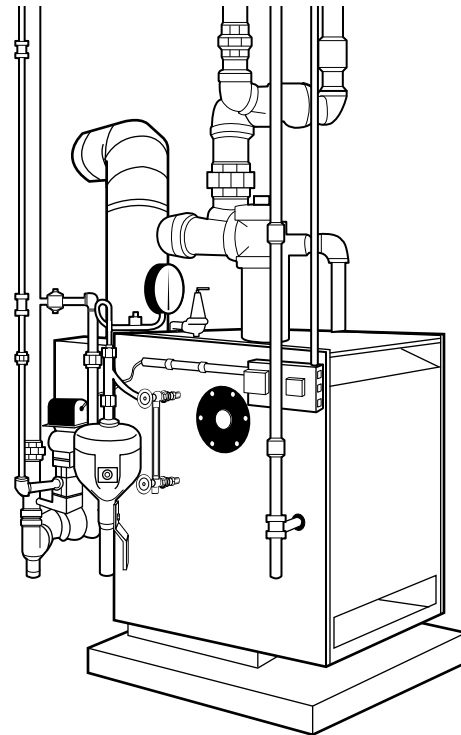

Steam Boiler

Fig. A

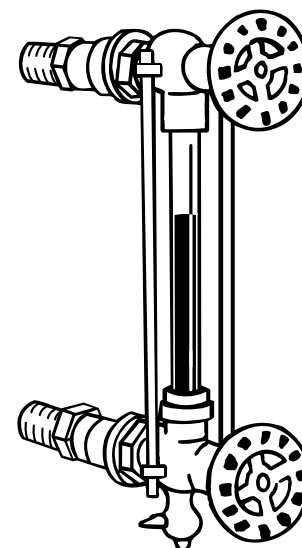

Gauge Glass Two-Thirds Full

Fig. B

Rating). This is a law of physics so it doesn't vary from manufacturer to manufacturer. If you're working with a boiler with a rating of, say, 1,000,000 BTU/HR, you can be assured the water is turning to steam and leaving that boiler at the rate of about two gpm. And it's leaving at speeds measured in miles per hour (sometimes exceeding 60 mph!). So it's very important for your near-boiler piping to be correct. If it's not, the fast moving steam will pull water out of the boiler and create problems for you in the system and the boiler.

As the water (in the form of steam) heads out toward the system, the water level in the boiler will, of course, drop. How far it drops, depends a lot on the size and condition of your piping system. You see, *ideally*, the water should begin to return to the boiler before the boiler's internal water line drops to a critical point. That's the point at which the low water cut-off will cut power to the burner, or an automatic water feeder will open.

Because the water is in the system piping and radiating during operation, the "normal" water level becomes a point that's somewhere in the lower-third of the gauge glass (Fig. C).

Remember, you're working with a *range* of operation here, not a fixed point. If the water were to stay at the top of the gauge glass all the while the burner was firing, you probably wouldn't be making steam! So don't get too caught up with the word "normal" because the only thing that's normal is that the water level will rise and fall.

Boiler manufacturers, as we said before, *do* establish a minimum safe water level for their boilers, however. That point is usually just out of sight of the bottom of the gauge glass. Should the water level drop to this point, the boiler may be in danger of overheating. We have to find a way to protect the boiler from itself (Fig. D).

All leading authorities and insurance companies recognize this need. The ASME Code for Low Pressure Heating Boilers, for instance, specifies, "*Each automatically fired steam or vapor steam boiler shall be equipped with an automatic low water fuel cut-off.*" The device the code refers to is what most people in the field commonly call a "low water cut-off." Its job is to stop the burner and protect the boiler.

What Causes a Low Water Condition?

Because it's an open system, some evaporative water loss is normal for a steam system. How much depends on the size and condition of the system. If you're losing too much water, however, it's time to begin troubleshooting. There are many places to look.

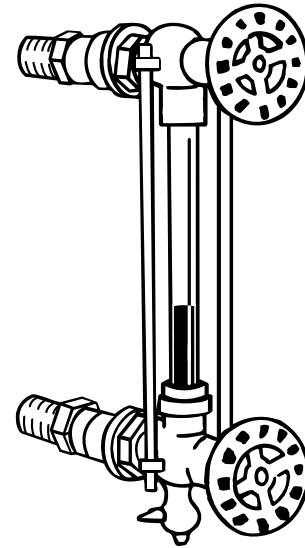

Gauge Glass One-Third Full

Fig. C

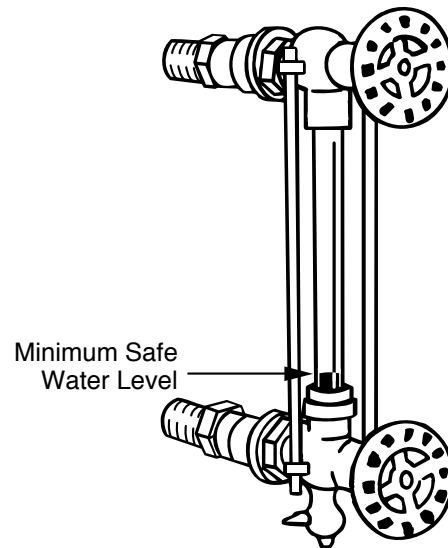

Gauge Glass Minimum Safe Water Level

Fig. D

Here are a few good places to start:

- The air vents are dirty, not seating properly, and passing steam to the atmosphere.
- Someone left the boiler blowdown valve partially open.
- Someone, for whatever reason, has been drawing hot water from the boiler.
- The relief valve has discharged.
- The condensate pump isn't working as it should.
 - The float may have come loose.
 - The condensate may be too hot to pump.
(Check those steam traps!)
- Improper near-boiler piping may be throwing water up into the system, or causing the waterline to tilt during operation.
- The wet returns may be leaking. (Always suspect *any* buried pipe).
- A check valve may be stuck closed or partially closed.
- The boiler may be foaming and priming.
 - Check the pH of the water. It should be between 7 and 9.
 - Check the condition of the water. Dirty water will prime and foam.
 - Check the burner's firing rate. Over-firing can cause priming.
- The pipes may not be properly pitched.
- The automatic feeder may not be working properly.
 - Its chamber may be filled with sediment.
 - Its feed line may be clogged.
- All of the condensate may not be returning from the system (a common problem with process applications).
- The boiler metal may be corroded and leaking at the water line.
 - Flood the boiler to its header to check for leaks.

Good troubleshooters take the time to look over the entire system before deciding what's wrong. Take the time to do it right, and you'll be the person with the answers.

Watching the Water Level

The best way to prevent overheating damage to a boiler is to stop the burner if the water level falls too low. This is the low water cut-off's job. There are several types of low water cut-offs you can use. Let's look at them.

Float Operated Low Water Cut-Offs

Float operated low water cut-offs have been around (Fig. E) since the 1920s and have earned a reputation worldwide for reliability. Usually, you'll mount this type of low water cut-off directly in the boiler's gauge glass tappings. We make "quick hook-up" fittings for these units to simplify installation.



Series 67 Float Type Low Water Cut-Off

Fig. E

The water level in the low water cut-off's chamber will mimic the water level in the boiler. As the water level drops in the boiler during steaming, the level in the chamber, and the cut-off's float drops with it. Should the float drop to the boiler's critical low water cut-off point, the float will trip an electrical switch that's wired in series with the burner. The burner instantly stops firing. It will stay off until the water level rises to a safe operating point.

This happens when the condensate returns from the system or when an automatic water feeder or a boiler attendant adds water to the boiler. When the level reaches a safe position, the low water cut-off will make its electrical connection and the burner will restart.

When a steam system is well balanced, the low water cut-off's job is to stand by and wait. The situation we just described suggests that there's something out of balance in that system. We'll look at this again in a few minutes.

Probe and Float Type Built-In Low Water Cut-Offs

There are some jacketed boilers that don't easily accept quick hook-up fittings. These boilers will often have a tapping for a built-in low water cut-off. These built-in units do the same thing as the external units we just looked at, but instead of being in a chamber, the "built-ins" are right inside the boiler where they can sense the water level directly.

We make two types of built-in low water cut-offs:

Probes – The boiler manufacturer will specify the point where they'd like to have this type of low water cut-off inserted. It will usually sit just below the water line, at a point above the boiler's crown. A probe uses the boiler's water to complete an electrical circuit past an insulator (the center portion of the probe) back to a ground (the threaded portion of the probe). As long as water covers the probe an electronic "go" signal will travel to the burner. When water drops off the probe for a continuous ten seconds, an electronic "stop" signal goes to the burner, shutting it down and protecting the boiler from a low water condition.

At McDonnell & Miller, we manufacture several different types of probe low water cut-offs to meet any of your job applications (Fig. F).

One of those applications might involve the boiler's water level. The water capacity of today's boilers is considerably less than that of boilers from decades ago. Along with this, the water level operating range of today's boilers is smaller. Further, the amplitude of surging water levels is increasing. As a result, the low water cut-off must be "smart" enough to recognize these variations and react appropriately. We have done this by



Series PSE-800 Probe Type Low Water Cut-Off

Fig. F

incorporating delay features in the probe's operating logic. These include a delay on break feature (DOB) which keeps the burner lit for 10 seconds after water leaves the probe. This minimizes the effects of a surging water line. Another addition – the delay on make feature (DOM) – allows an additional feed time of 30 seconds once water comes in contact with the probe. This minimizes rapid burner and feeder cycling by slightly elevating the water level so that water lost to steaming will return (in the form of condensate) before the water level drops below the probe.

Float Type – In operation, these are similar to the external, float operated low water cut-offs we looked at before. The difference is that instead of sensing a duplicated water level *outside* the boiler, these units sense the level directly inside the boiler.

We make them for you in five mounting-barrel sizes (Series 69) to accommodate different boiler insulation thicknesses. When you select a built-in, float type control make sure it fits as far as possible into the boiler, without the float shield coming contact with the boiler.

When a low water cut-off stops a burner, it also stops the entire heating system. Nothing will happen until the water in the boiler returns to a safe operating level.

While this is very good for the boiler, it may not be the best thing for the system. If the heat in the building is off for too long a time, water pipes may begin to freeze.

This is where automatic water feeders come in. An automatic feeder will maintain a safe minimum water level in the boiler and keep it operating, even if the system is leaking. It keeps the system operating automatically until you can make the repairs.

Combination Low Water Cut-Offs and Automatic Water Feeders

Two of our most popular and versatile feeders are the Uni-Match® and the 101A (Fig. G and H). These are ideal for use in residential or small commercial applications. They are versatile in that they are compact and they are easily installed to operate with either a probe type OR a float type low water cut-off. These feeders are always ready to add water when given the signal from the low water cut-off. The benefits they offer are the convenience of not having to manually add water – and most importantly – they will protect the boiler from a dry fire condition by maintaining a safe minimum water level in the boiler should a system leak occur.

If you use a mechanical automatic water feeder, you can keep your burner operating even during a power failure.



Series WFE Uni-Match® Water Feeder

Fig. G



Series 101-A Water Feeder

Fig. H

A mechanical feeder can also protect a boiler (Fig. I) should a fuel-regulating device malfunction, causing the burner to lock in and stay there. Or suppose someone jumps-out a control, putting the burner on continuous operation. A mechanical automatic water feeder will continue to feed the boiler whenever the level drops to the “feed” point.

Under normal circumstances, the electrical low water cut-off (the second part of the feeder/cut-off combination) is always standing by, ready to shut off the burner should something go wrong with the automatic feeder.

An automatic water feeder doesn’t feed at the two-thirds full point on the gauge glass. You set this by hand when you first start the system. As we said before, the “normal” level will range up and down as the system operates. An automatic feeder will maintain a safe *minimum* water line only. By doing this, it will lessen the possibility of human error.

Consider this. A boiler attendant might put too much water in a steam boiler. He doesn’t have an automatic feeder and he’s tired of checking the water level every day so he fills the boiler to the two-thirds full point while it’s operating. When the condensate returns, the boiler floods. By adding water the attendant has limited the boiler’s steam-making space. Without enough room to break free of the water, the steam will now carry water up into the system piping. This leads to higher fuel bills, uneven heating, water hammer, scale formation in the boiler and burner short-cycling. Suddenly, problems plague this system, and no one is sure why.

Automatic water feeders help you avoid these problems. They watch that water level, maintaining a safe *minimum*. They allow the boiler water line to rise and fall naturally through its normal operating range.

How a Feeder/Cut-Off Combination Works

During Normal Operation – This is how a McDonnell & Miller feeder/cut-off combination looks on a steam boiler (Fig. J). Notice how we have it installed well below the boiler’s “normal” start-up operating range (that’s about two-thirds up the gauge glass). We don’t want it to feed while the water is out in the system as steam.

Remember, the automatic water feeder is there to maintain a safe minimum water line, not a “normal,” start-up water line.

As you now see it in the drawing, the feeder is closed and the burner is firing. The boiler is working, sending steam out to the building, and both the automatic water feeder and low water cut-off are standing by.

The Feeder Opens – If the boiler’s water line drops to the feeder/cut-off combination’s feeder-operating point (which is very near the bottom of the gauge glass) (Fig. K), the feed valve will open mechanically and add water to the



Series 47-2 Combination Mechanical Water Feeder/Low Water Cut-Off

Fig. I

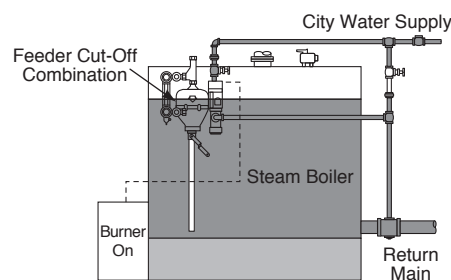

Normal Operation

Fig. J

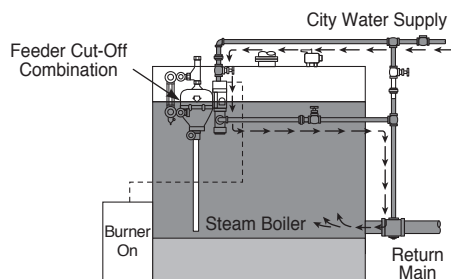

Feeder Open & Burner On

Fig. K

boiler. How much water will enter the boiler depends on several things, but there will always be enough to keep the boiler operating at a safe *minimum* water level. Once it has added the right amount of water, the feeder closes.

While this is happening, the burner continues to run because the feeder keeps the boiler from dropping to its low water cut-off point.

The Low Water Cut-Off Stops the Burner – But suppose something happens and the automatic water feeder can't keep up with the rate at which the boiler is losing water. Suppose, for instance, that a pipe breaks or someone opens a boiler drain, causing the boiler to suddenly lose water. Should this happen, the water level will drop to a preset point, and the automatic feeder/cut-off combination will instantly cut power to the burner, shutting it down and protecting the boiler from a dry-firing condition. Though the burner is off, the automatic feeder will continue to add water to the boiler in an attempt to restore a safe minimum water level (Fig. L).

As you can see, a combination *mechanical* water feeder and *electrical* low water cut-off provides you with boiler protection even if the power fails or something goes wrong in the burner circuitry.

Combination Water Feeders and Low Water Cut-Offs for Larger Boilers

As we said earlier, all steam boilers evaporate water at the rate of one-half gpm per 1,000 square feet EDR (240,000 BTU/HR). To satisfy a larger boiler's needs, an automatic water feeder must be able to match the boiler's higher steaming rate. If the feeder can't keep up, the burner will suffer from nuisance low water shutdowns. To avoid this problem, we make automatic feeder/cut-off combinations with wider flow orifices to meet the special needs of larger boilers. The operation of these larger units is the same as the ones we just looked at. The key difference is the increased flow rate (Fig. M).

Once the larger feeder/cut-off combination satisfies the boiler's minimum water line needs, it has to be able to close against the force of the city water pressure moving through that extra wide orifice. This calls for considerable float and lever power, and it explains why our feeder/cut-off combinations for larger boilers are bigger than those for smaller boilers. We've carefully engineered them to get the maximum closing force in the space we have to work with. This ensures the unit will close tightly once it's done its job (Fig. N).

Codes call for larger boilers to have their gauge glasses mounted on water columns, rather than directly into the boiler. Consequently, we make our larger automatic

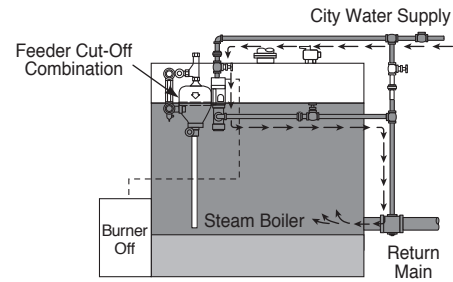

Feeder Open & Burner Off

Fig. L

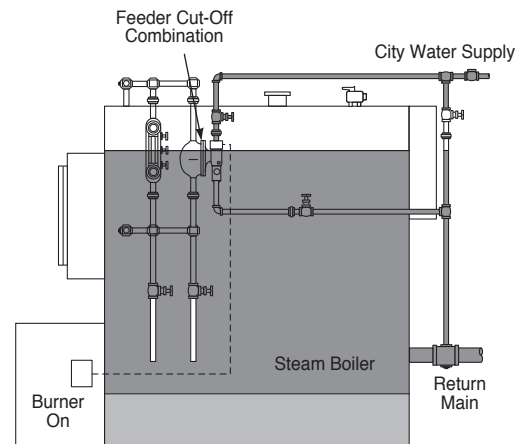

Large Boilers

Fig. M



Series 51-2 Mechanical Water Feeder

Fig. N

water feeders and feeder/cut-off combinations without “quick hook-up” fittings. Instead, we give these larger combinations one-inch (25mm), float chamber tappings so you can mount them directly on an equalizing line.

Watching the Water Level in Process/ Space-Heating Boilers

Now let’s suppose you’re installing a steam boiler in a factory. Some of the total steam load will travel to unit heaters where it will keep the workers warm. The rest of the steam will go to a steam table in the cafeteria, a dishwasher, an oil preheater on the boiler, a few sterilizing cabinets on the plant floor, and a half dozen other process applications.

This job offers a special challenge because a good portion of the condensate won’t be working its way back to the boiler. Some of this condensate is tainted in the process and we need to handle it specially. Because of this, you’re going to have to consistently add feed water to keep this process/space heating boiler operating.

If you use a combination feeder/cut-off on this job you may run into a problem because the vertical space on the control between its “feed” point and its “cut-off” point is relatively small. The feeder might not be able to keep up with the system’s process needs, and if it can’t, the boiler might drop into a low water condition and shutdown.

It’s best to install a *separate* automatic feeder and low water cut-off on a job such as this when you know some condensate won’t be returning (Fig. O). Set up this way, the feeder can open fully and deliver its maximum capacity to the boiler before the low water cut-off (installed at a lower level) goes into action. By piping the system like this, you eliminate nuisance burner cut-offs while meeting both your heating and process needs.

When you select the water feeder and low water cut-off for your process/space heating application, always check to make sure the operating pressure of your system doesn’t exceed the maximum operating pressure of either control.

The Importance of System Balance

Steam Systems With Condensate Pumps

Most two-pipe steam systems, and some one-pipe steam systems, need help returning condensate to the boiler (Fig. P). The pump’s job is to provide the “push” the water needs to get back into the boiler. The water leaves the boiler as steam, condenses into a liquid in the radiators and piping, and flows by gravity into a

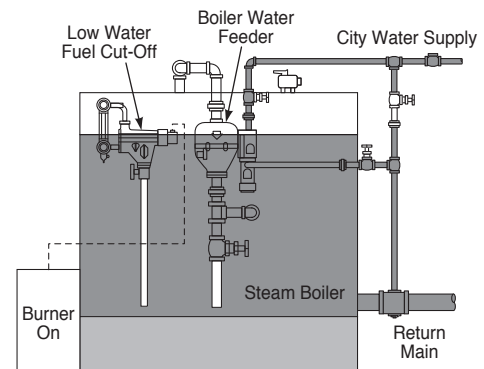

Separate Water Feeder
Process/Semi-Process System

Fig. O

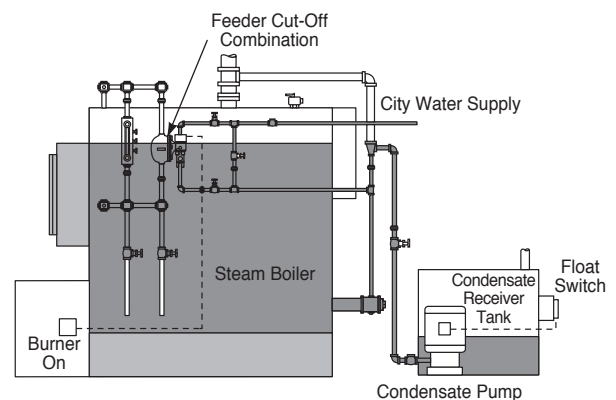

Single Boiler
Balanced System

Fig. P

condensate receiver. When the water level inside the receiver reaches a certain point, an electrical float switch turns the pump on. The pump quickly moves the water out of the receiver and back into the boiler.

Steam boilers served by condensate pumps also need low water protection, and our low water cut-offs serve that purpose well. You can also use an automatic water feeder or a combination feeder/cut-off on these systems. But before you do, make sure the system is well balanced. What we mean by “well balanced” is that the condensate pump should be able to return the water to the boiler before the boiler’s water level drops to a point where the low water cut-off or automatic feeder goes into action.

If the automatic water feeder adds water to the boiler (to maintain a safe minimum operating level), and *then* the condensate pump returns its water to the boiler, the boiler will most likely wind up with too much water. This excess water limits the boiler’s steam making space. Without enough room to break free of the water, the steam can carry water up into the system piping. That leads to higher fuel bills, uneven heating, water hammer, scale formation in the boiler and burner short cycling.

So before you use an automatic water feeder on a steam boiler that’s served by a condensate pump, check to see if the system is well balanced. It should run through its cycles without going off on low water. In other words, the condensate pump should balance the flow of water back into the boiler before the level drops to the critical, low water point. Keep in mind that a system with a condensate pump can become unbalanced if the returns clog with sediment or if any steam traps fail in an open position.

Good troubleshooters always keep their eyes wide open.

Steam Systems with Boiler-Feed Pumps

If you have a system where some steam is going for process (meaning, it won’t be coming back), or if your system isn’t well balanced, you should consider using a boiler feed pump instead of a condensate pump.

A boiler feed pump serves the same purpose as a condensate pump (Fig. Q). It provides the “push” the water needs to get back into the boiler. The difference between a condensate pump and a boiler feed pump, however, lies in the way we control the two units. Instead of having an electrical float switch inside the condensate receiver, a boiler feed pump takes its orders from a McDonnell & Miller pump controller mounted directly on the boiler.

The pump controller has two switches. The first switch (set at the higher of the two levels) operates the boiler feed pump. When the boiler needs water, the pump

controller recognizes the need and starts the pump. When the boiler water returns to the proper level in the gauge glass, the pump controller stops the pump. Should the pump not be able to keep up with the boiler’s need for water, the pump controller will sense this as well. The second switch (set at the lower of the two levels) will cut the electricity to the burner and protect the boiler from a low water condition (Fig. R).

Feed water enters the system through a make-up water feeder in the boiler feed pump’s receiver. If you wish, you can add a feeder/cut-off combination to operate at a level a bit lower than the pump controller. This will give you a mechanically operated feeder, which will act as a back-up should something go wrong with the pump controller. It will also give you a secondary low water cut-off. It’s like having a belt *and* suspenders for your boiler!

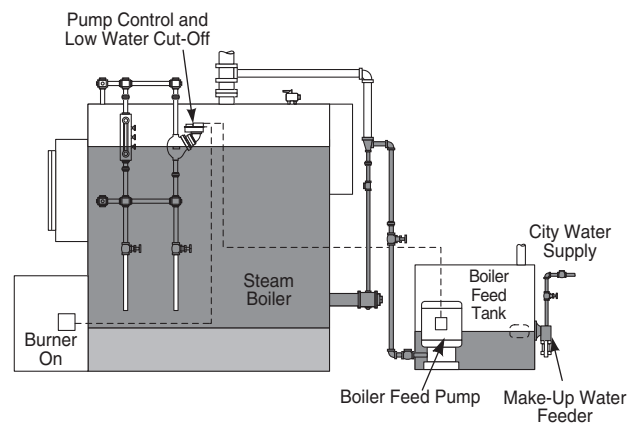

Single Boiler
Unbalanced System

Fig. Q

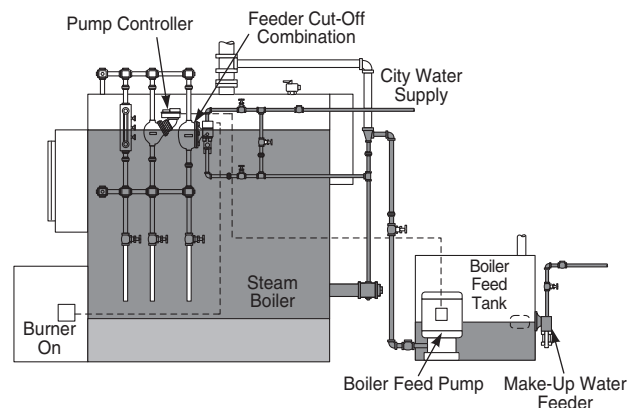

Single Boiler
Feeder/Cut-Off Combination – Unbalanced System

Fig. R

Meeting the Needs of Systems with Multiple Steam Boilers

(Fig. S, T U)

The boiler on the right may be a stand-by to the boiler on the left. Every week or so, a boiler attendant might switch them, making this one the operating boiler and the other the stand by.

It's a good idea, one we've used for years in larger boiler rooms. By having more than one boiler, each is able to supply the entire needs of the system. Your chances of getting caught without steam are much less.

Some systems have multiple steam boilers. The idea here is to let several boilers join forces to meet the total needs of the system. The goal is energy conservation. You steam all the boilers on start-up, and then shut a few down after you've heated the system and satisfied the piping pick-up load. In other words, you put the system on "simmer" after you've heated it completely.

Steam systems with more than one boiler often have problems if the installer fails to realize that steam is dynamic and not static. By this, we mean that steam is always moving *very* quickly from the boiler to the system, and as it moves, it loses pressure. And since one ounce of pressure represents a water column 1³/₄ in. (45mm) high, the slightest difference in pressure between any two boilers interconnected on their return sides can make a big difference in the individual water levels.

A slight burr in a pipe or fitting can create a drop in pressure. You can never tune two burners to produce the same flame. One boiler will always be closer to the system take-off than another. These things speak loudly for proper piping and thoughtful management of the boiler water line so that's what we'll look at next.

Multiple Boiler Systems with a Boiler Feed Pump and Motorized Return Valves

Here we have two boilers served by a single boiler feed pump (Fig. S). One boiler may be a stand by to the other, or they may be sharing the total load. For piping purposes, we'd handle either application the same way.

Notice how the condensate returns are independent. Each flows from the boiler feed pump receiver to the boiler through a motorized valve. This is an important detail. If you were to interconnect the returns, the water from one boiler would flow into the other.

Steam Moves – Remember, steam is dynamic, not static. Water doesn't "seek its own" level when the steam is moving out of the boiler. The slightest difference in firing rate or piping pressure drop between the two boilers will cause one to flood and the other to shut down due to a low water condition. This is why those independent returns are important. We're using motorized valves on this installation (Fig. S) to isolate one boiler from the other. When either boiler needs water, the McDonnell & Miller pump controller on that boiler will drop to a point where it will close the higher of its two switches. That switch will power that boiler's motorized valve, causing it to open. When it's fully opened, the motorized valve will trip an end switch and start the boiler feed pump. Water will flow only to the boiler that needs it. The float in the pump controller will sense the rising water. When the water reaches the proper level, the pump controller will break the electrical connection to the motorized valve. The valve will begin to close, shutting off the boiler feed pump as it does.

As you can see, when we pipe multiple boilers this way it doesn't matter how big or small each is. The boiler feed pump, although sized for the *total* needs of all the boilers, will satisfy the needs of each in turn, no matter what size.

Keeping the Water Flowing – We've installed a make-up water feeder in the boiler feed pump's receiver tank. It's job is to maintain a minimum water line in the tank so the pump will always have a reservoir from which it can draw feed water. In this system, all the water will enter the boilers through the boiler feed pump. If, for any reason, the boiler feed pump can't keep up with the boiler's rate of evaporation, the water line in the boiler will drop. The lower switch in the McDonnell & Miller pump controller will stop the burner.

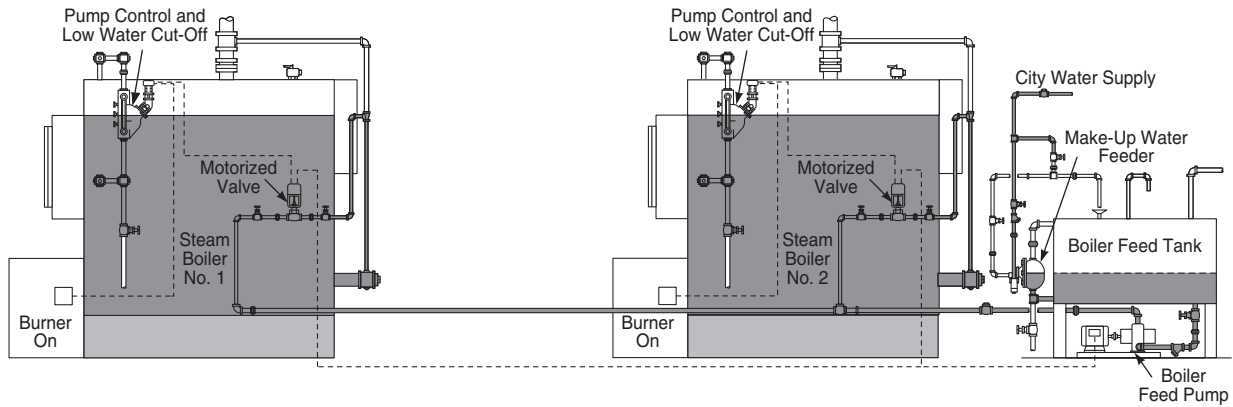

Multiple Boilers
Boiler Feed Pump and Motorized Valves

Fig. S

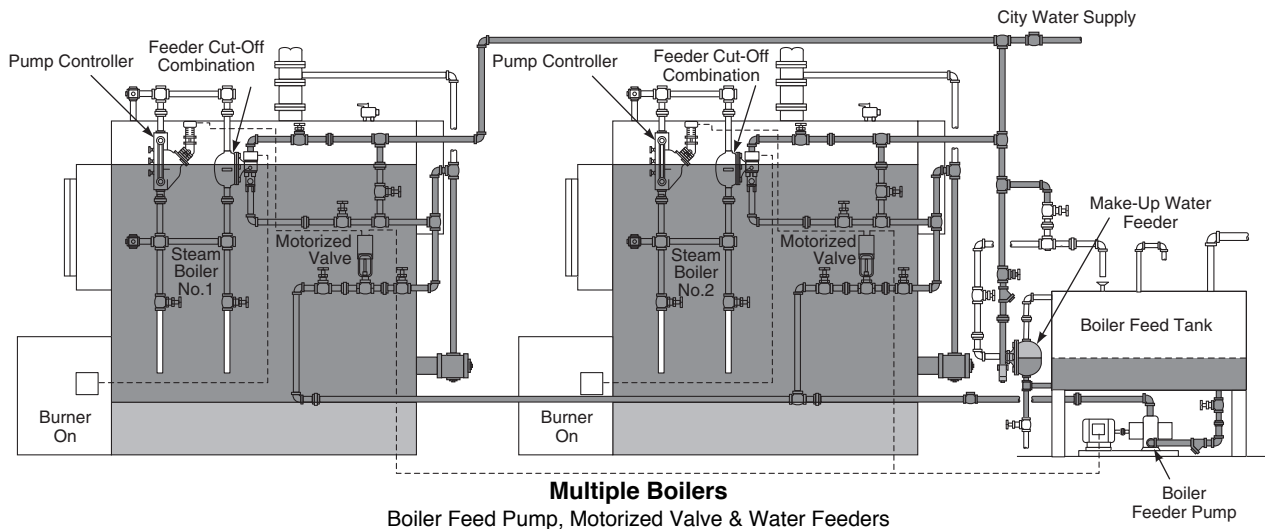

Multiple Boilers
Boiler Feed Pump, Motorized Valve & Water Feeders

Fig. T

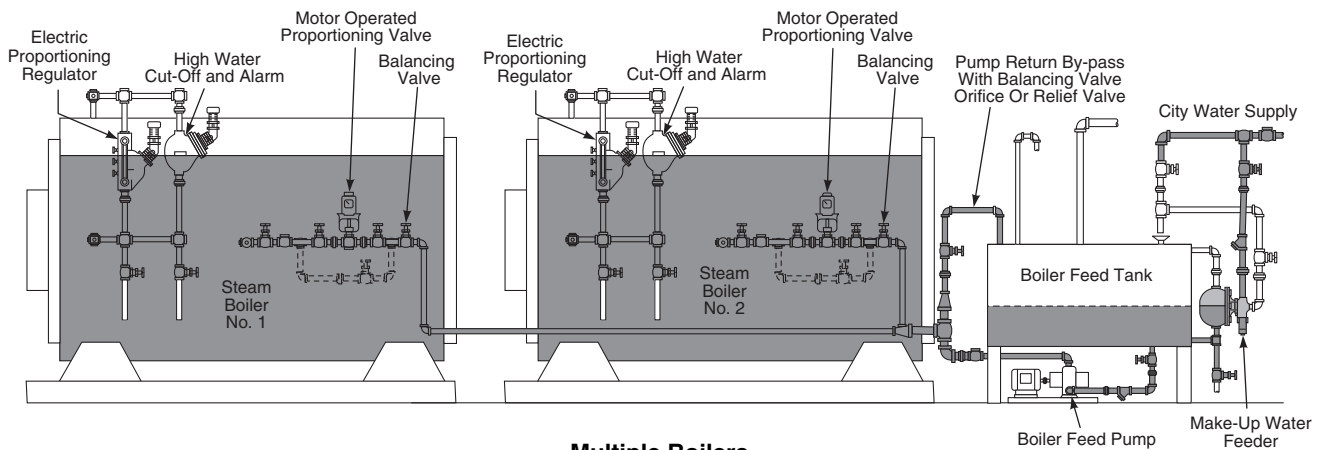

Multiple Boilers
Boiler Feed Pump, Electric Proportioning Regulators and Motorized Valves

Fig. U

If you find the pump suddenly can't keep up with the boiler's needs, check the temperature of the returning condensate. As thermostatic radiator steam traps and end of main F&T traps age and fail, they pass steam into the returns. That can make the condensate hot enough to "flash" when it hits the pump's impeller. Boiler feed pumps can't move water once it has flashed to steam. The pump will turn and cavitate, but it won't satisfy the boiler.

Ideally, in a low pressure steam heating system, the condensate in the pump's receiver shouldn't be hotter than 180°F (82°C).

Multiple Boiler Systems with a Boiler Feed Pump, Motorized Return Valves and Boiler Water Feeders (Fig. T)

This is the same system we just looked at, except we've added a combination automatic water feeder and low water cut-off to a point just below the pump controller. The feeder/cut-off's job will be to add water mechanically to the boiler should something happen to the boiler feed pump (for instance, if it's cavitating because the return condensate is too hot).

Think of the feeder/cut-off as a back-up device to keep the boiler in operation should something go wrong elsewhere. The low water cut-off will back up the pump controller's primary low water cut-off should something go wrong there, or if the feeder can't keep up with the boiler's rate of evaporation for some reason.

Multiple Boiler Systems with a Boiler Feed Pump, Motorized Return Valves and Electric Proportioning Regulator (Fig. U)

Here we're controlling the water lines with electric proportioning regulators. We're matching the incoming feed water to the exact amount of water that's leaving as steam. By doing this, we're able to maintain a precise water line in both boilers and take advantage of each boiler's full steaming space.

There are times when steaming loads will vary tremendously. This is especially true of steam heating systems in larger buildings. We often set up these buildings to operate on outdoor air temperature sensors and night set-back devices. When the system first starts in the morning the boilers will steam longer than they will during the day when the pipes and radiators are hot. This is also true of seasonal operation when you run the heating system less often.

This is when proportioning regulators can make a big difference. By closely monitoring the water line, regardless of varying system conditions, you improve the quality of steam leaving the boiler and allow the system to operate more efficiently.

Receiver Tank Control

If you size a boiler feed pump's receiver properly it will be able to hold the right amount of water to keep the boiler operating during the start-up cycles. It will also be able to receive the returning condensate without overflowing.

Receiver sizing is more an art than a science. You have to look closely at the entire system to figure out how long it will take the condensate to return from the building. There are many variables to consider: The type and condition of steam traps, the pitch and cleanliness of steam mains and returns, the pipe insulation or lack of it, the shape of the building and how people use it.

There are also the times when you'll have to deal with condensate transfer pumps, or maybe a vacuum/condensate pump. These pumps collect and relay return water back to the boiler feed pump. There are many things that can affect how quickly these secondary pumps move condensate back to the primary boiler feed pump. You have to consider them all when you're sizing a feed pump receiver.

One thing will be a constant, however. There must always be enough water in the receiver for the boiler to draw from during the start-up cycle (the time between initial steaming and the return of condensate from the building). A McDonnell & Miller make-up feeder, set at the one-third full point on the receiver tank, will meet the boiler's needs during this crucial start-up time. Let's take a closer look at these.

Receiver Tank Make-Up Water Feeders

Here, we've mounted a McDonnell & Miller make-up water feeder on a one-inch NPT equalizing line that extends from the top of the tank to the bottom. The level in the feeder's chamber will be the same as the level in the tank. As the pump moves water out of the tank and into the boiler, the float inside the feeder's chamber will open and constantly replenish the tank's reservoir.

We've designed our feeders with the right amount of float and lever power to close tightly against city water pressure. This ensures that there will always be enough tank space to receive the returning condensate without having it overflow.

If the tank you're using doesn't have tappings for an equalizing line, you can use our internal feeder (Fig. V). As you can see, it mounts directly inside the tank and feeds water through its integral strainer. We make this unit with two flange sizes for both new and retrofit installations.

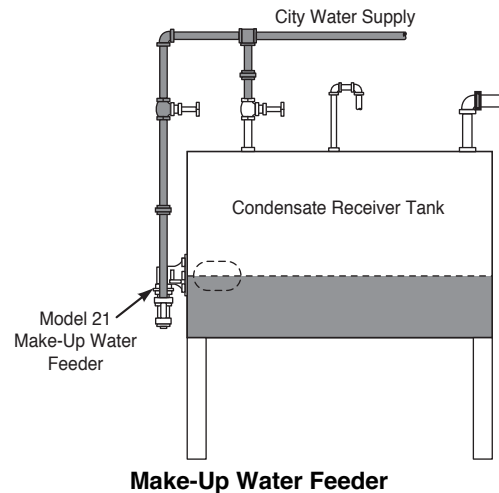
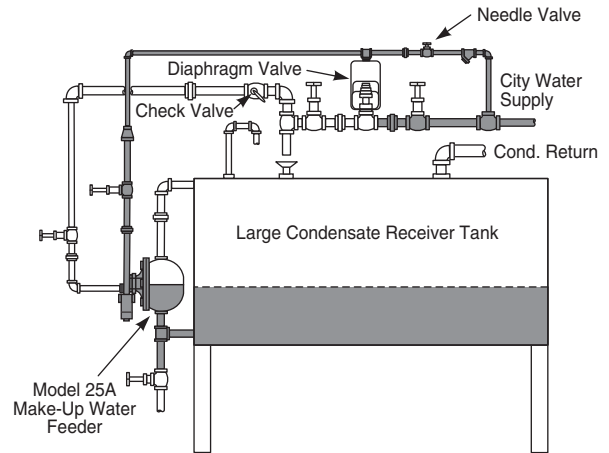

Fig. V

A Make-Up Water Feeder Used as a Pilot Valve (Fig. W)

When you have multiple boilers, the boiler feed pump has to be able to meet the needs of *all* the boilers should they need water simultaneously. During the start-up cycle, the draw from the feed pump's receiver can be very heavy and the make-up feeder has to be able to match that flow.

When we run into this situation, we often use a make-up water feeder as a pilot valve to operate a high capacity diaphragm valve with "dead-end" service. When the feeder opens it signals the diaphragm valve to snap into action. The larger valve quickly maintains the receiver at the one-third full point. Once the feed pump shuts off the dead-end service valve closes tightly to prevent over filling. If returned condensate fills the receiver, the feed valve, of course, stays closed. This piping arrangement also gives you a lot of freedom because you can put the diaphragm valve in a remote location, if you'd like, for easier service.



**Make-Up Water Feeder
Used as Pilot Valve**

Fig. W

A Make-Up Water Feeder with a Motorized Valve (Fig. X)

Here's another way you can quickly fill the receiver. Use a McDonnell & Miller controller to sense the tank's water line. As the level rises and falls, the controller will electrically operate a high capacity motorized valve.

This is another piping arrangement that gives you a lot of freedom. You can place that motorized valve anywhere you'd like.

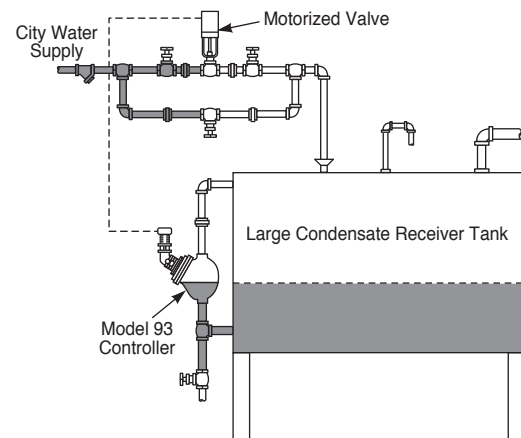

**Make-Up Water Feeder
and Motorized Valve**

Fig. X

Low Water Cut-Offs for Receiver Tanks (Fig. Y)

There's always the possibility for human error on any job. For instance, suppose someone decides to turn off the water supply to your receiver tank. The pump controller on the boiler will still start the pump, but once the receiver goes dry there won't be any water to pump because of the closed valve. Or suppose the building loses water pressure and the feed pump suddenly finds itself moving more water than the water feeder can replace. If the pump runs dry, it will cavitate and its mechanical seal will quickly heat and break. That leaves you with a costly repair and system down time.

If you install a low water cut-off in an equalizing line around the tank, the cut-off will protect the pump no matter what happens.

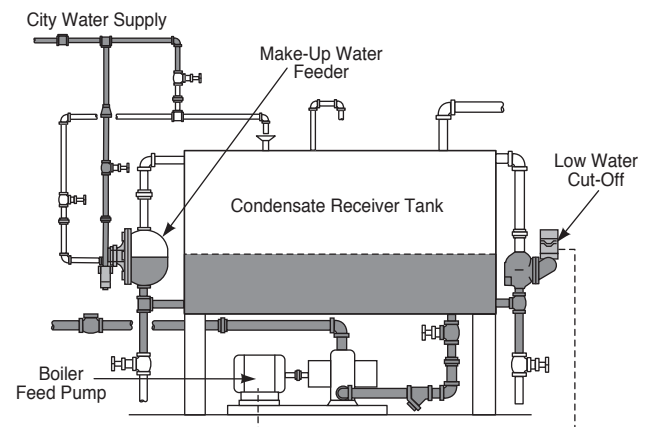

**Low Water Cut-Off
on Receiver Tank**

Fig. Y

Hot Water Boilers

Low water protection isn't just for steam boilers. Hot water boilers face the same perils of overheating damage if the water line drops too low. Many people don't think of this as often as they should because hot water boilers serve "closed" systems. They have pressure reducing valves that are supposed to feed water automatically should a leak develop.

The truth, however, is that a pressure reducing valve is no substitute for a low water cut-off. Pressure reducing, or "feed" valves, often clog with sediment and wind up not feeding at all. A buried pipe can corrode and spring a leak that flows faster than a "feed" valve can satisfy. Relief valves can pop and, while dumping water at a great rate, actually prevent the feed valve from operating.

Let's take a closer look at how we can protect these boilers.

Hot Water Systems (Fig. Z)

As we said, the things that affect steam boilers also affect hot water boilers. If you run them with too much water the relief valve will open. If you run them with too little water they'll overheat and suffer damage.

A low water cut-off is the only sure way of protecting a hot water boiler from sudden loss of water. The ASME boiler code recognizes this by requiring all hot water boilers of 400,000 BTU/HR or more input to have low water fuel cut-off devices.

ASME doesn't call for low water cut-offs on smaller, residential boilers, but we think *all* hot water boilers, regardless of their size, must have protection. However, the International Mechanical Code requires low water cut-offs on **ALL** hot water and steam boilers. McDonnell & Miller make several devices, both float and probe type, that protect and meet the needs of any boiler whether it's cast iron, steel, or copper construction (Fig. AA, BB, CC).

Hot water systems regularly lose water through faulty air vents, loose valve stem packing, cracked boiler sections, loose nipples, corroded pipes, broken or loose pump seals, leaking gaskets, dripping relief valves, to name just a few places. Most installers depend on their pressure reducing or feed valve, to replace the lost water automatically. But feed valves often clog with sediment, especially in hard water areas. And it's very easy to close the supply valve to a feed valve and forget to open it again.

On systems with buried pipes (say, a radiant heating system) a feed valve will open if a pipe breaks. It will feed fresh water continuously until it either clogs (and stops feeding) or destroys the ferrous components of the system with oxygen corrosion. A simple feed valve can wind up costing a lot more than its purchase price. This is why major suppliers of feed valves, such as Bell & Gossett, recommend you close the feed valve once you've established your initial fill pressure.

This is also why we strongly recommend you use a low water cut-off on every hot water boiler. Feed valves are not a substitute for low water cut-offs. They can't protect your boilers from a low water condition. Feed valves are fine for filling the system initially, and for helping you vent air from the radiators. But once the system is up and running, you shouldn't look to them for protection.

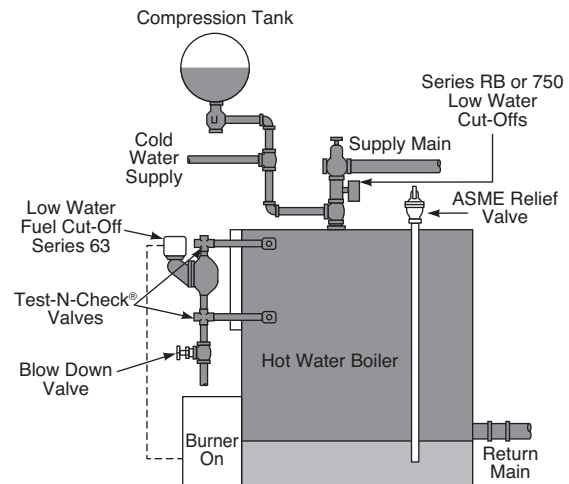

Hot Water Boiler

Fig. Z

Over firing

There are times when hot water boilers don't lock-out on safety. Whether by control failure or human error, things go wrong. And when they go wrong in a hot water heating system, the water temperature can rise quickly to a point where the expansion tank can't take up the expansion of the water. This causes the relief valve to discharge.

When the relief valve opens, there's a sudden drop in system pressure. The water, which at this point is probably much hotter than 212°F (100°C), will flash into steam. This is why ASME insists that relief valves for hot water boilers carry steam-discharge ratings.

If a feed valve doesn't open to replace this rapidly exiting water, a low water condition will quickly result. The only thing that can protect the boiler at this point is a low water cut-off. The feed valve can't protect the boiler because its typical setting is 12 psig (.83 bar). In other words, the system pressure must drop below 12 psig (.83 bar) before the feed valve will open.

The trouble is that while the relief valve is open and flashing steam to atmosphere, the internal system pressure never drops anywhere near 12 psig (.83 bar). A relief valve with a 30 psig (2.1 bar) setting, for instance, will open at 30 psig (2.1 bar), and close again when the pressure drops to about 26 psig (1.79 bar). The result is a loss of water with no make-up. Repeat this cycle enough times and the boiler will be in a dangerous, low water condition. Keep in mind, steam exerts pressure. It can easily fool a feed valve, and that's why feed valves offer very little protection at all against low water.



Series 67 Float Type Low Water Cut-Off

Fig. AA



Series 751P/752P Probe Type Low Water Cut-Off

Fig. BB



Series RB-24E Probe Type Low Water Cut-Off

Fig. CC

Feeder/Cut-Off Combinations for Cast Iron and Steel Hot Water Boilers (Fig. DD)

To protect a boiler from dry firing, the low water cut-off must be located above the boiler's crown. After the low water cut-off shuts off the burner, you should have a way to add water to the system to ensure the crown stays under water.

A combination water feeder and low water cut-off can do this for you. If you position the feeder above the boiler's crown, it will mechanically feed water if the level should drop to that point. This is an important consideration because, even if the electricity is cut off, it's possible for the firing cycle to continue if the fuel feed valve is mechanically locked open. The combination unit's cut-off switch will act as a back-up to the primary low water cut-off, providing the boiler with additional protection.

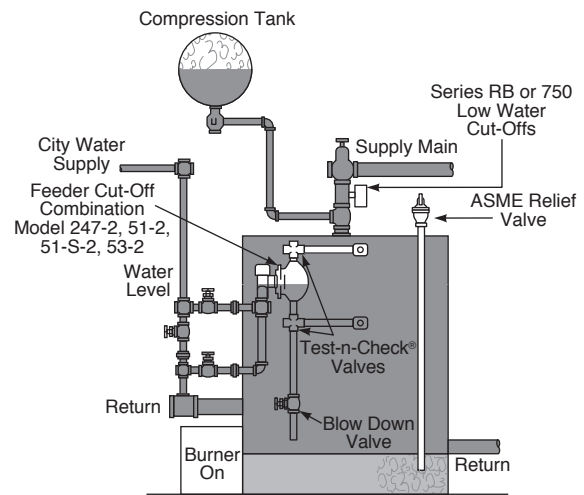

Hot Water Boiler

Fig. DD

Protecting Copper Fin Tube Boilers (Fig. EE)

Copper fin tube boilers move heat from the flame to the water almost instantly. This type of boiler depends on the proper flow of water across its heat exchanger to move the heat quickly out of the boiler and into the system. Should flow stop while the burner is operating, heat will quickly build and cause the water in the heat exchanger to flash into steam. This condition is similar to a dry firing in a cast iron or steel boiler.

A McDonnell & Miller flow switch, installed on the copper fin tube boiler's hot water outlet, protects it from this danger (Fig. FF). The burner cannot fire unless water is moving across the flow switch. When the flow stops, for whatever reason, the McDonnell & Miller flow switch immediately cuts electrical power to the burner and protects the boiler from overheating.

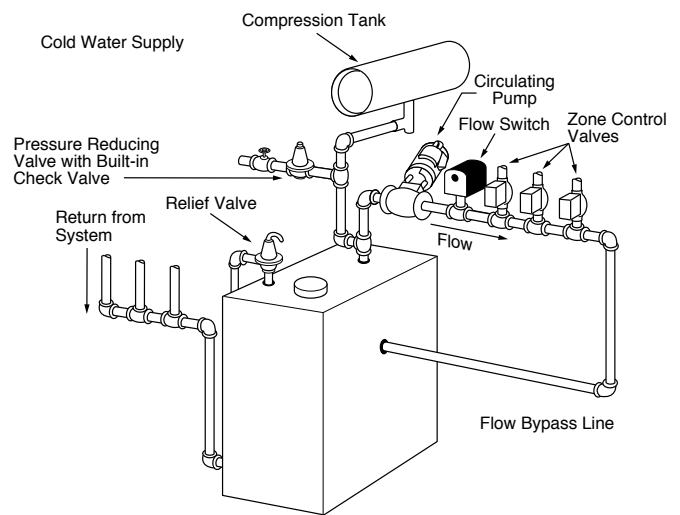

Copper Fin Tube Boiler

Fig. EE



Series FS4-3 Flow Switch
(shown without paddle)

Fig. FF

Pressure Relief Valves

(Fig. GG, HH)

Good engineering practice calls for every hot water boiler to have a pressure relief valve. This spring-loaded valve must be able to release the boiler's entire load at the boiler's maximum operating pressure.

Here are some things that can cause a relief valve to open in a hot water heating system:

- The automatic feed valve fails, allowing higher than normal pressure to enter the system.
- Someone leaves a hand bypass line open after filling the system.
- Someone hydrostatically tests the system at a pressure greater than the relief valve's setting.
- The air cushion in the diaphragm type compression tank doesn't match the system's static fill pressure. Keep in mind, most tanks come from the factory precharged at 12 psig (.83 bar). If the system needs more than 12 psig (.83 bar) pressure, you have to add more air to the tank, and you have to do this while you have the tank disconnected from the system.
- The compression tank may be too small for the system.
- The boiler's aquastat is in a well without heat transfer grease. When this happens, the boiler's temperature will quickly exceed the aquastat's setting, causing rapid rise in system pressure.
- The circulator may be on the return side of the system with the compression tank at its suction. If it is, the circulator's head pressure will appear inside the boiler as a net increase. It may be enough to open the relief valve.
- The burner limit may be jumped-out or stuck in a manual position.

The main thing to keep in mind when you're troubleshooting this one is that relief valves pop when any of these three things happen:

- The compression tank loses its air cushion
- The system takes on more water.
- The system temperature increases.

Think methodically, and keep your eyes wide open!

We hope this Basic System Operation Guide has given you insight into the systems on which you're now working or will face in the future. We welcome any questions or comments you may have about the Guide, or about our products.

Thanks for your support, and for your continuing business.

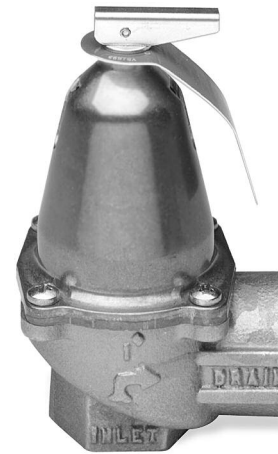

Series 250 Pressure Relief Valve

Fig. GG



Series 260 Pressure Relief Valve

Fig. HH

Hot Water Boilers

McDonnell & Miller Low Water cut-offs are specially designed to protect hot water boilers from the hazards of a low water condition. In operation they will interrupt the electrical current to the firing device, if the water in the system drops below the boiler manufacturer's minimum safe water level.

Our low water cut-offs also provide an additional circuit for a low water alarm, should you desire to install one, for additional protection.

How to Select Low Water Cut-Offs for Hot Water Boilers

Boiler pressure and the method of mounting are the primary factors to consider when selecting a low water cut-off.

Product Series	Size NPT	Maximum Boiler Pressure psi (kg/cm ²)	Method of Installation		Blow Down Valve	
			Directly into Boiler Tappings OR on the Boiler Supply Riser*	To Piping Above the Boiler with 1" (25mm) Equalizing Piping	Required	Provided with Low Water Cut-Off
RB-24E	3/4	50 (3.5)	X		No	N/A
63	1			X	Yes	No
64	1			X	Yes	No
64-A	1/2		X		Yes	Yes
764	2 1/2		X		Yes	No
751P/752P	3/4	160 (11)	X		No	N/A
RB-122E	3/4		X		No	N/A
750	3/4 - 1	160 - 250 (11-18)	X		No	N/A

* Use the tapping designated by the boiler manufacturer for low water cut-off installation.

Steam Boilers

McDonnell & Miller Low Water Cut-offs are specially designed to protect steam boilers from the hazards of a low water condition. In operation they will interrupt the electrical current to the firing device, if the water in the system drops below the boiler manufacturers' minimum safe water level.

Our low water cut-offs also provide an additional circuit for a water feeder or a low water alarm, should you desire to install one, for additional protection.

We recommend that secondary (redundant) Low Water Cut-Off controls be installed on all steam boilers with heat input greater than 400,000 BTU/hour or operating above 15 psi of steam pressure. At least two controls should be connected in series with the burner control circuit to provide safety redundancy protection should the boiler experience a low water condition. Moreover, at each annual outage, the low water cut-offs should be dismantled, inspected, cleaned, and checked for proper calibration and performance.

How to Select Low Water Cut-Offs for Steam Boilers

Boiler pressure and the method of installation are the primary factors to consider when selecting a low water cut-off.

Product Series	Size NPT	Maximum Boiler Pressure psi (kg/cm ²)	Method of Installation		Blow Down Valve	
			Directly into Boiler Tappings*	Connect to the Boiler with 1" Equalizing Piping	Required	Provided with Low Water Cut-Off
PSE-800	¾	15 (1)	X		No	N/A
750	¾		X		No	N/A
61	1	20 (1.4)		X	Yes	No
67	½		X		Yes	Yes
767	2½		X		Yes	Yes
69	2½		X		No	N/A
42S	1	50 (3.5)		X	Yes	No
42S-A	½		X		Yes	Yes
63	1			X	Yes	No
64	1			X	Yes	No
64-A	½		X		Yes	Yes
764	2½		X		Yes	No
93/193	1	150 (10.5)		X	Yes	No
150S	1			X	Yes	No
157S	1			X	Yes	No
94/194	1¼	250 (18)		1¼	Yes	No
750B-C3/C4	1			X	Yes	No

* Use the tapping designated by the boiler manufacturer for low water cut-off installation.

How to Select Controls

STEAM BOILERS

Steam Heating Boilers are classified as boilers in closed heating systems where all condensate is returned to the boiler. Best recommendation for all automatically fired boilers is a feeder cut-off combination. It adds water as needed to maintain a safe operating level, and stands by to interrupt circuit to burner if water level drops into emergency zone.

Steam Process Boilers are classified as boilers in systems where not all the condensate is returned, and some make-up water is needed. A separate feeder and separate cut-off are recommended, so operating levels can be set for the wider differential required in such service.

Selection of the correct feeder cut-off combination, or feeder depends upon:

1. Maximum boiler pressure.
2. Differential between water supply pressure and the pressure setting of the steam safety valve.
3. Boiler size

HOT WATER BOILERS

Best recommendation for all automatically fired boilers is a feeder cut-off combination. It adds water if needed to match the discharge capacity of the relief valve, and stands by to interrupt circuit to burner if water level drops into emergency zone.

Selection of the correct feeder cut-off combination, or feeder depends upon:

1. Maximum boiler pressure.
2. Differential between water supply pressure and the pressure setting of the safety relief valve.
3. Boiler size

Boiler Rating			
BTU	HP	EDR	Cond. Lb./Hr
33,475	1	140	34.5
66,950	2	280	69
167,375	5	700	173
251,063	7.5	1,050	259
334,750	10	1,400	345
418,438	12.5	1,750	431
502,125	15	2,100	518
585,813	17.5	2,450	604
669,500	20	2,800	690
836,875	25	3,500	863
1,004,250	30	4,200	1,035
1,171,625	35	4,900	1,208
1,339,000	40	5,600	1,380
1,506,375	45	6,300	1,553
1,673,750	50	7,000	1,725

Conversion Factors

$$\text{Boiler Horsepower (BHP)} = \frac{\text{EDR}}{139}$$

$$\text{Gallons of Water} = \frac{\text{Lbs. of Water}}{8.33}$$

$$\text{BTUH} = \text{EDR} \times 240$$

$$\text{EDR} = \frac{\text{BTUH}}{240}$$

$$\text{BTUH} = \text{BHP} \times 33,479$$

Boiler Steaming Rate (Gallons Per Minute)

$$\text{GPM} = \frac{\text{EDR}}{2000}$$

$$\text{GPM} = (\text{BHP}) \times 0.069$$

$$\text{GPM} = \frac{\text{BTU}}{480,000}$$

$$\text{GPM} = \text{EDR} \times 0.000496$$

$$\text{Pounds of condensate per hour} = \frac{\text{EDR}}{4}$$

Water Feeders and Combination Water Feeders/Low Water Cut-Offs

McDonnell & Miller Boiler Water Feeders and Feeder Cut-Off Combinations are used to provide automatic operation, and to safeguard steam and hot water boilers against the hazards of a low water condition.

A feeder cut-off combination mechanically adds water as needed to maintain the required minimum water level, and electrically stops the firing device in case of an emergency.

How to Select Water Feeders (continued)

Steam Boilers

Series	Characteristics	Maximum Boiler Pressure psi (kg/cm ²)	Boiler Size (Mfr. Gross Rating Sq. Ft. of EDR)						
			*Differential Pressure psi (kg/cm ²)						
			10 (.7)	20 (1.4)	30 (2.1)	40 (2.8)	50 (3.5)	60 (4.2)	70 (4.9)
Uni-Match®	For Automatic Fired Heating Boilers	15 (1.0)	All Boilers up to 5,000 sq. ft.						
101A	For Automatic Fired Heating Boilers	25 (1.8)	All Boilers up to 5,000 sq. ft.						
47	For Heating or Process Boilers	25 (1.8)	All Boilers up to 5,000 sq. ft.						
47-2	For Automatic Fired Heating Boilers	25 (1.8)	All Boilers up to 5,000 sq. ft.						
247	For Heating or Process Boilers	30 (2.1)	All Boilers up to 5,000 sq. ft.						
247-2	For Automatic Fired Heating Boilers	30 (2.1)	All Boilers up to 5,000 sq. ft.						
51	For Heating or Process Boilers	35 (2.5)	8,600	12,000	15,000	17,600	20,000	21,800	23,400
51-2	For Automatic Fired Heating Boilers	35 (2.5)	8,600	12,000	15,000	17,600	20,000	21,800	23,400
51S	For Heating or Process Boilers	35 (2.5)	10,500	17,500	22,400	26,500	30,000	32,600	35,000
51S-2	For Automatic Fired Heating Boilers	35 (2.5)	10,500	17,500	22,400	26,500	30,000	32,600	35,000
53	For Heating or Process Boilers	75 (5.3)	8,600	11,600	14,600	17,000	18,800	20,600	22,100
53-2	For Automatic Fired Heating Boilers	75 (5.3)	8,600	11,600	14,600	17,000	18,800	20,600	22,100

*Differential pressure should be based on water supply pressure at boiler, minus pressure setting of steam safety valve

Low Water Cut-Offs – Electronic For Hot Water and Steam Boilers

Series 750



- For commercial or industrial applications
- Primary or secondary control on hot water boilers
- Secondary control (manual reset models only) on steam boilers
- Manual reset models meet the requirements of **ASME Standard CSD-1**. If the control is in a low water condition when there is an interruption of power, the control will remain in a low water condition when power is restored. The reset button will need to be pressed when the water level is restored to a level above the probe to allow the burner to fire.

Standard Features

- Green LED indicating power is on
- Red LED indicating low water condition
- Test button
- No lock out with loss of power if probe is in water
- 20,000 ohms sensitivity

Model 750-HW-MT-120

The 750-HW-MT-120 control provides continuous protection against a **HIGH WATER** condition in steam boilers and other water level applications. The manual reset function will require the unit be reset after water has risen above the level of the probe.

Ordering Information

Model Number	Part Number	Description	Weight lbs. (kg)
750-T-24	176294	LWCO - 24V Auto Reset	2 (.9)
750-MT-24	176293	LWCO - 24V Manual Reset	2 (.9)
750-T-120	176206	LWCO - 120V Auto Reset	2 (.9)
750-MT-120	176207	LWCO - 120V Manual Reset	2 (.9)
750-HW-MT-120	176236	HWCO - 120V Manual Reset	2 (.9)

(Remote sensor and probe rod must be ordered separately, see page 70-72)

Dimensions, in. (mm)

A	B	C	D
6 $\frac{3}{8}$ (162)	5 $\frac{1}{8}$ (130)	2 $\frac{9}{16}$ (65)	1 $\frac{9}{16}$ (40)



Series 750
Control Unit

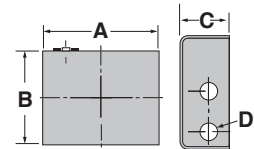

Control Unit

Temperature Ratings:

Temperature:

Storage: -40°F to 120°F (-40°C to 49°C)

Ambient: 32°F to 120°F (0°C to 49°C)

Humidity: 85% (non-condensing)

Electrical Enclosure Rating: NEMA 1 General Purpose

Hz: 50/60

Control Power Consumption: 3 VA (max.)

Electrical Ratings

Model	Voltage	Switch Rating (Amperes)		Pilot Duty
		Full Load	Locked Rotor	
24 VAC	24 VAC	—	—	50 VA at 24 VAC
120 VAC	120 VAC	7.5	43.2	125 VA at 120 VAC 50 or 60 Hz

Low Water Cut-Offs – Electronic For Hot Water and Steam Boilers

Series 751P/752P



- For commercial or industrial applications
- Primary or secondary control on hot water boilers
- Secondary control (manual reset models only) on steam boilers
- Manual reset models meet the requirements of **ASME Standard CSD-1**. If the control is in a low water condition when there is an interruption of power, the control will remain in a low water condition when power is restored. The reset button will need to be pressed when the water level is restored to a level above the probe to allow the burner to fire.

Standard Features

- Green LED indicating power is on
- Red LED indicating low water condition
- Test button
- Self cleaning probe
- No lock out with loss of power if probe is in water
- 20,000 ohms sensitivity

Electrical Ratings

Model	Voltage	Switch Rating (Amperes)		Pilot Duty
		Full Load	Locked Rotor	
24 VAC	24 VAC	—	—	50 VA at 24 VAC
120 VAC	120 VAC	7.5	43.2	125 VA at 120 VAC 50 or 60 Hz

Ordering Information

(Remote sensor must be ordered separately (see page 70-74))

Model Number	Part Number	Description	Weight lbs. (kg)
752P-MT-24	176296	LWCO - 24V w/standard probe	2.5 (1.1)
752P-MT-U-24	176298	LWCO - 24V w/ext. barrel probe ('U')	2.5 (1.1)
752P-MT-SP-24	176297	LWCO - 24V w/short probe ('SP')	2.5 (1.1)
751P-MT-120	176234	LWCO - 120V w/standard probe	2.5 (1.1)
751P-MT-U-120	176214	LWCO - 120V w/ext. barrel probe ('U')	2.5 (1.1)
751P-MT-SP-120	176295	LWCO - 120V w/short probe ('SP')	2.5 (1.1)

Dimensions, in. (mm)

A	B	C	D			E			F	G
			Std.	SP	U	Std.	SP	U		
6 ⁵ / ₈ (168)	5 ⁵ / ₁₆ (135)	2 ³ / ₄ (70)	1 ¹ / ₁₆ (40)	3 ¹ / ₁₆ (78)	1 ⁹ / ₁₆ (40)	2 ¹ / ₈ (54)	1 ⁵ / ₁₆ (33)	1 ⁹ / ₁₆ (40)	3/4	7/8 (22)



Series 751P/752P

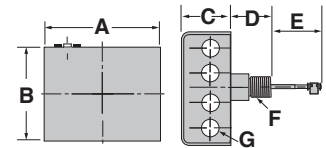

Probe Specifications

- Maximum Steam Pressure:** 15 psi (1.0 kg/cm²)
- Maximum Water Pressure:** 160 psi (11.2 kg/cm²)
- Maximum Water Temperature:** 250°F (121°C)
- Probe Sensitivity:** 20,000 ohm

Control Unit

Temperature Ratings:

Temperature:

Storage: -40°F to 120°F (-40°C to 49°C)

Ambient: 32°F to 120°F (0°C to 49°C)

Humidity: 85% (non-condensing)

Electrical Enclosure Rating: NEMA 1 General Purpose

Hz: 50/60

Control Power Consumption: 3 VA (max.)

Low Water Cut-Offs – Electronic For Steam Boilers

Series PSE-800

For commercial steam boiler applications

The Series PSE-800 probe type LWCO uses patented technology to monitor changes in water conductivity. When defined parameters are exceeded the new PSE-800 makes a decision to shut the burner off based on the volatility/variability of the resistance settings. This new patented technology provides the best protection possible without turning off the boiler unless a low water condition exists. As an added measure of safety, the control will turn off the boiler if it recognizes an out-of-water condition when the sensitivity threshold is exceeded.

Standard Features

- Green LED indicating power is on
- Red LED indicating low water condition
- 30 second DOM
- Test button
- Self-Cleaning probe
- No lock out with loss of power if probe is in water
- Provisions to add water feeder of alarm

Models available with:

- 120 VAC
- 24 VAC
- 'U' probe (extended barrel)
- 'RX2' probe (remote)

Electrical Ratings

Model	Voltage	Switch Rating (Amperes)		Pilot Duty
		Full Load	Locked Rotor	
24 VAC	24 VAC	—	—	50 VA at 24 VAC
120 VAC	120 VAC	7.5	43.2	125 VA at 120 VAC 50 or 60 Hz

Ordering Information

Model Number	Part Number	Description	Weight lbs. (kg)
PSE-801-120	153827	LWCO - 120V	2.7 (1.2)
PSE-801-U-120	153828	PSE-801-120 w/ext. barrel ('U' probe)	2.7 (1.2)
PSE-802-24	153927	LWCO - 24V	2.7 (1.2)
PSE-802-U-24	153928	PSE-802-24 w/ext barrel ('U' probe)	2.7 (1.2)
PSE-802-RX2-24	153929	PSE-802-24 w/remote sensor ('RX2' probe)	2.7 (1.2)

Dimensions, in. (mm)

A	B		C				D	E	F	G	H		J	K
	All	U	Std	SP	RX2	U					All	RX		
4¼ (108)	1⅞ (40)	3⅞ (78)	2½ (54)	1⅞ (35)	2⅞ (54)	1⅞ (40)	¾ (20)	1⅞ (21)	5⅜ (148)	1⅞ (35)	¾ (20)	½ (25)	2⅞ (73)	⅞ (22)

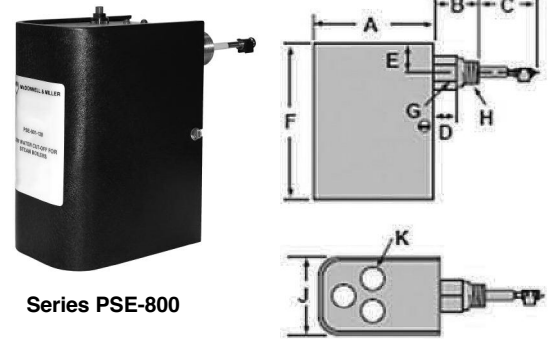
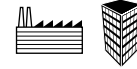

Probe Specifications

Maximum Steam Pressure: 15 psi (1.0 kg/cm²)

Maximum Water Pressure: 160 psi (11.2 kg/cm²)

Maximum Water Temperature: 250°F (121°C)

Probe Sensitivity: 7,000 ohm

Control Unit

Temperature:

Storage: -40°F to 120°F (-40°C to 49°C)

Ambient: 32°F to 120°F (0°C to 49°C)

Humidity: 85% (non-condensing)

Low Water Cut-Offs – Electronic For Steam Boilers

PSE-800-M Manual Reset LWCO

- Primary or Secondary control on hot water boilers
- Secondary control on steam boilers
- Manual reset models meet requirements of **ASME Standard CSD-1**. If the control is in a low water condition when there is an interruption of power, the control will remain in a low water condition when power is restored. The reset button will need to be pressed when the water level is restored to a level above the probe to allow the burner to fire.

Standard Features

- Green LED indicating power is on
- Red LED indicating low water condition
- 60-second delay before lockout.
- Test button
- Self-Cleaning probe
- No lock out with loss of power if probe is in water

Electrical Ratings

Model	Voltage	Switch Rating (Amperes)		Pilot Duty
		Full Load	Locked Rotor	
24 VAC	24 VAC	—	—	50 VA at 24 VAC
120 VAC	120 VAC	7.5	43.2	125 VA at 120 VAC 50 or 60 Hz

- Probe Sensitivity: 7,000 ohms
- Probe Consumption: 1.7 VA @ 24 VAC
3.6 VA @ 120 VAC
- Enclosure Rating: NEMA 1 General Purpose

Ordering Information

Model Number	Part Number	Description	Weight lbs. (kg)
PSE-801-M-120	153601	120V Manual Reset w/standard probe	2.7 (1.2)
PSE-801-M-U-120	153603	120V Manual Reset w/ext. barrel probe ('U')	2.7 (1.2)
PSE-802-M-24	153602	24V Manual Reset w/standard probe	2.7 (1.2)
PSE-802-M-U-24	153604	24V Manual Reset w/ext. barrel probe ('U')	2.7 (1.2)

Dimensions, in. (mm)

A	B		C		D	E	F	G	H	J	K
	All	U	Std	U							
4¼ (108)	1½ (40)	3½ (78)	2½ (54)	1½ (40)	1¼ (20)	1⅞ (21)	5⅞ (148)	1 (35)	¾ (20)	2⅞ (73)	⅞ (22)

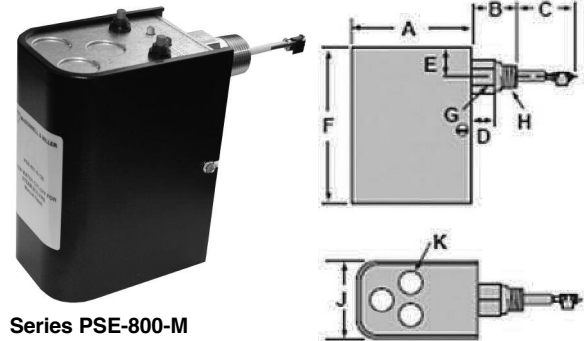

Probe Specifications

- Maximum Steam Pressure:** 15 psi (1.0 kg/cm²)
- Maximum Water Pressure:** 160 psi (11.2 kg/cm²)
- Maximum Water Temperature:** 250°F (121°C)
- Probe Sensitivity:** 7,000 ohm

Control Unit

Temperature:

Storage: -40°F to 120°F (-40°C to 49°C)

Ambient: 32°F to 120°F (0°C to 49°C)

Humidity: 85% (non-condensing)



Do not use "manual reset" models with electric automatic water feeders. Failure to follow this caution can cause flooding and property damage.

Low Water Cut-Offs – Electronic



RB-24E

Low Water Cut-Offs



- Brass threads enable a secure and trouble-free installation
- Test button to confirm proper operation
- Universal wiring harness fits 100% of today's gas boilers
- -S, -A, -B and -L models provide “plug & play” installation with most residential boilers
- Compact size
- Easy to install and wire
- Automatic reset feature resumes operations after a power outage when water is on probe
- Green LED indicating power is on
- Red LED indicating low water condition
- Solid state operation
- 15,000 ohms probe sensitivity
- Maximum ambient temperature 120°F (49°C)
- Maximum water temperature 250°F (121°C)
- Maximum water pressure of 160 psi (11.2 kg/cm²)

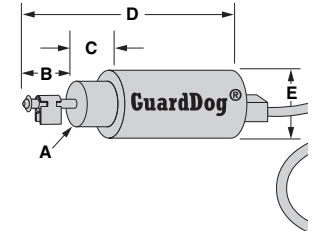

RB-24E

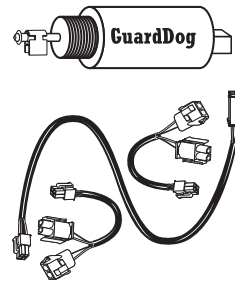

RB-24E-S

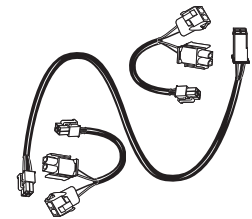

UWH-RB-24S

Electrical Ratings

Voltage	Power Consumption	Load Switching
24 VAC	2.5 VA	2 A at 24 VAC

Note: A 15 mA minimum current draw is required.

Dimensions, in. (mm)

A NPT	B	C	D	E
3/4	1 1/16 (30.2)	1 1/16 (30.2)	5 3/4 (180)	1 7/8 (47.6)

Ordering Information

Model Number	Part Number	Description
RB-24E	144692	Residential LWCO
RB-24E-A	144694	Residential LWCO w/vent damper harness
RB-24E-B	144696	Residential LWCO w/burner control harness
RB-24E-S	144693	Residential LWCO w/control board harness
RB-24E-L	144690	Residential LWCO w/burner control harness
UWH-RB-24A	144681	Replacement cable for RB-24E-A
UWH-RB-24B	144695	Replacement cable for RB-24E-B
UWH-RB-24S	144682	Replacement cable for RB-24E-S
UWH-RB-24L	144691	Replacement cable for RB-24E-L

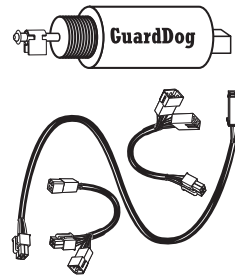

RB-24E-A

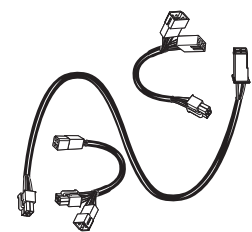

UWH-RB-24A

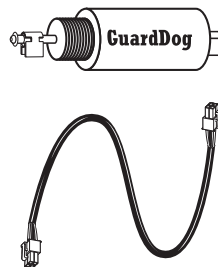

RB-24E-B
RB-24E-L

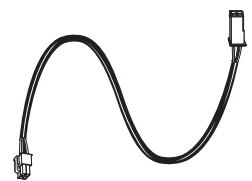

UWH-RB-24B
UWH-RB-24L

Low Water Cut-Offs – Electronic For Hot Water Boilers

RB-122-E

Low Water Cut-Offs 



- For residential and commercial applications
- Electronic operation
- Easy to install and wire
- Red LED indicating low water condition
- Green LED indicating power is on
- Test button
- Automatic reset
- No blow down required
- 20,000 ohms probe sensitivity
- Maximum ambient temperature 120°F (49°C)
- Maximum water temperature 250°F (121°C)
- Maximum water pressure 160 psi (11.2 kg/cm²)



RB-122-E

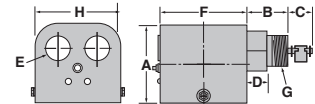

Electrical Ratings

Voltage	Power Consumption	Load Switching
120 VAC	3.1 VA	5.8 A at 120 VAC

Dimensions, in. (mm)

A	B	C	D	E	F	G NPT	H
2 ³ / ₄ (70)	1 ⁵ / ₈ (51)	1 ³ / ₈ (35)	3 ⁴ / ₄ (20)	7 ⁸ / ₈ (22)	3 ¹³ / ₁₆ (99)	3 ⁴ / ₄	3 ³ / ₁₆ (81)

Ordering Information

Model Number	Part Number	Description	Weight lbs. (kg)
RB-122-E	144676	Low water cut-off	1.7 (.78)

Low Water Cut-Offs – Mechanical For Steam Boilers

Series 61 Low Water Cut-Offs



- For residential and commercial low pressure steam boiler applications
- For boilers of any steaming capacity
- Adjustable BX outlet for easy installation
- Dual precision switches for dependable operation of the low water cut-off and alarm or electric water feeder
- Packless bellows
- 1" NPT equalizing pipes and blow down valve required
- Maximum steam pressure 20 psi (1.4 kg/cm²)



Series 61

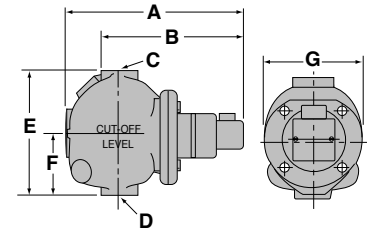

Electrical Ratings

Voltage	Motor Switch Rating (Amperes)		Pilot Duty
	Full Load	Locked Rotor	
120 VAC	7.4	44.4	125 VA at 120 or 240 VAC
240 VAC	3.7	22.2	

Dimensions, in. (mm)

A	B	C NPT	D NPT	E	F	G
9 ¹⁵ / ₁₆ (252)	7 ⁷ / ₁₆ (189)	1	1	6 ¹ / ₂ (165)	3 ¹ / ₈ (79)	5 ¹ / ₈ (130)

Ordering Information

Model Number	Part Number	Description	Weight lbs. (kg)
61	140100	Low water cut-off	13.5 (6.1)

Low Water Cut-Offs – Mechanical For Steam and Hot Water Boilers

Series 63 Low Water Cut-Offs

- For residential, commercial, and industrial applications
- Heavy duty
- Includes No. 2 switch
- Optional manual reset available
- Maximum boiler pressure 50 psi (3.5 kg/cm²)
- Use with TC-4 on hot water systems

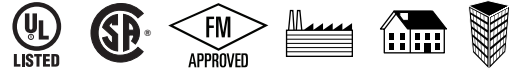

Series 63

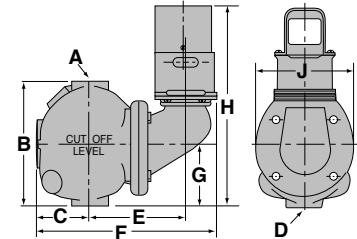

Electrical Ratings

Voltage	Motor Switch Rating (Amperes)		Pilot Duty 125 VA at 120 or 240 VAC 60 Hz
	Full Load	Locked Rotor	
120 VAC	10.2	61.2	
240 VAC	5.1	30.6	

Dimensions, in. (mm)

A NPT	B	C	D NPT	E	F	G	H	J
1	6½ (165)	2⅞ (65)	1	5½ ₃₂ (131)	9⅜ (238)	3⅛ (79)	10½ (267)	5⅞ (130)

Ordering Information

Model Number	Part Number	Description	Weight lbs. (kg)
63	142400	Low water cut-off	13.5 (6.1)
63-B	142700	63 w/ float block	15.0 (6.8)
63-BM	143300	63 w/float block & manual reset	15.0 (6.8)
63-M	143100	63 w/manual reset	14.0 (6.4)

Low Water Cut-Offs – Mechanical For Steam and Hot Water Boilers

Series 64

Low Water Cut-Offs

- For residential, commercial, and industrial boiler applications of any steaming capacity
- Heavy Duty
- Adjustable BX outlet for easy installation
- Dual precision switches for dependable operation of the low water cut-off and alarm or electric water feeder
- Packless bellows
- Optional manual reset available (manual reset switch must be ordered separately)
- 1" (25mm) NPT equalizing pipes required
- Maximum boiler pressure 50 psi (3.5 kg/cm²)
- Use with TC-4 on hot water systems



SERIES 64

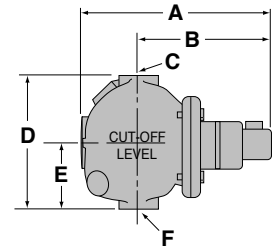

Dimensions, in. (mm)

A	B	C NPT	D	E	F NPT
9 ¹⁵ / ₁₆ (252)	7 ⁷ / ₁₆ (65)	1	6 ¹ / ₂ (165)	3 ¹ / ₈ (79)	1

Model 64-A

Low Water Cut-Offs

- Quick hook-up fittings provided for installation directly into gauge glass tapings



Model 64-A

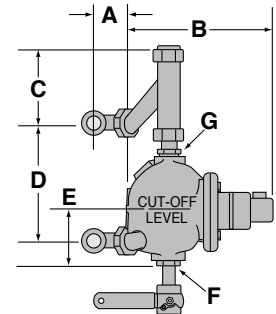

Dimensions, in. (mm)

A	B	C	D		E	F NPT	G NPT
			min.	max.			
2 ⁵ / ₈ (66)	9 ¹⁵ / ₁₆ (252)	4 ¹ / ₂ (113)	6 ⁷ / ₈ (172)	13 ³ / ₈ (339)	3 ¹ / ₈ (79)	1	1

Ordering Information

Model Number	Part Number	Description	Weight lbs. (kg)
64	143600	Low water cut-off	11.3 (5.1)
64-A	143700	64 w/quick hook-up fittings	18.3 (8.3)
64-B	143800	64 w/float block	11.5 (5.2)

Electrical Ratings

Voltage	Motor Switch Rating (Amperes)		Pilot Duty
	Full Load	Locked Rotor	
120 VAC	7.4	44.4	125 VA at 120 or 240 VAC
240 VAC	3.7	22.2	

Low Water Cut-Offs – Mechanical For Steam and Hot Water Boilers

Series 764 Low Water Cut-Offs

- For residential, commercial, and industrial boiler applications of any steaming capacity
- Heavy duty
- Adjustable BX outlet for easy installation
- Dual precision switches for dependable operation of the low water cut-off and alarm or electric water feeder
- Packless bellows
- 2½" NPT side tapping provided for installation with close nipple
- Maximum boiler pressure 50 psi (3.5 kg/cm²)

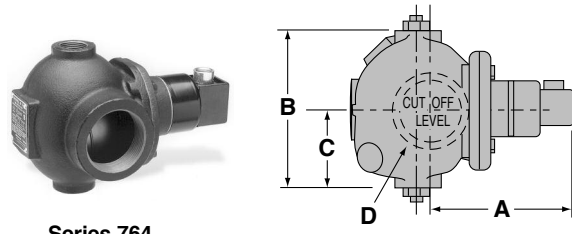

Series 764

Electrical Ratings

Voltage	Motor Switch Rating (Amperes)		Pilot Duty
	Full Load	Locked Rotor	
120 VAC	7.4	44.4	125 VA at 120 or 240 VAC
240 VAC	3.7	22.2	

Dimensions, in. (mm)

A	B	C	D
6⅞ (175)	6½ (165)	3⅞ (79)	2½ NPT

Ordering Information

Model Number	Part Number	Description	Weight lbs. (kg)
764	144500	Low water cut-off	12.5 (5.7)

Low Water Cut-Offs – Mechanical For Steam Boilers

Series 67 Low Water Cut-Offs

- For residential and commercial applications
- For boilers of any steaming capacity
- Quick hook-up fittings provided
- Lever-operated, full port ball valve for easy blow down
- Adjustable BX outlet for easy installation
- Dual precision switches for dependable operation of the low water cut-off and alarm or electric water feeder
- Optional features
 - Low voltage switches for self-generating millivolt circuits
 - Manual reset switch (manual reset switch must be ordered separately)
- Large float chamber
- Maximum steam pressure 20 psi (1.4 kg/cm²)

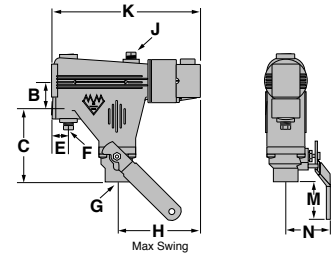
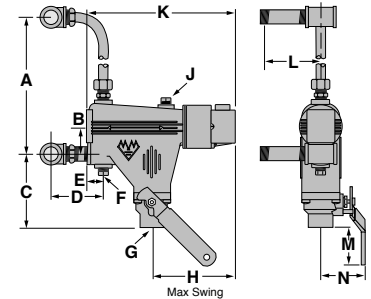

Electrical Ratings

Voltage	Motor Switch Rating (Amperes)		Pilot Duty
	Full Load	Locked Rotor	
120 VAC	7.4	44.4	125 VA at 120 or 240 VAC
240 VAC	3.7	22.2	

Dimensions, in. (mm)

A		B	C	D	E	F	G	H	J	K	L	M	N
min.	max.					NPT	NPT		NPT				
6½ (165)	14 (356)	1¾ (45)	4¾ (121)	3¾ (86)	1⅛ (29)	¾	¾	5½ (140)	¼	9 ²³ / ₃₂ (247)	3 ⁹ / ₁₆ (90)	2½ (64)	2 ¹³ / ₁₆ (71)

Ordering Information

Model Number	Part Number	Description	Weight lbs. (kg)
67	149400	Low water cut-off	10 (4.5)
67-G	149600	67 for millivolt service	10 (4.5)
67-LQHU	149500	67 without quick hook-up fittings	8 (3.6)

Low Water Cut-Offs – Mechanical For Steam Boilers

Series 767 Low Water Cut-Offs

- For residential and commercial low pressure boiler applications
- For boilers of any steaming capacity
- 2½" NPT body tapping for side mounting on boilers
- Lever-operated, full port ball valve for easy blow down
- Adjustable BX outlet for easy installation
- Dual precision switches for dependable operation of the low water cut-off and alarm or electric water feeder
- Large float chamber
- Maximum steam pressure 20 psi (1.4 kg/cm²)



Series 767

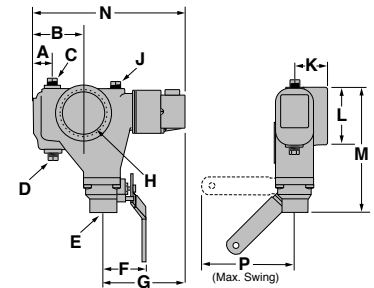

Electrical Ratings

Voltage	Motor Switch Rating (Amperes)		Pilot Duty
	Full Load	Locked Rotor	
120 VAC	7.4	44.4	125 VA at 120 or 240 VAC
240 VAC	3.7	22.2	

Dimensions, in. (mm)

A	B	C NPT	D NPT	E NPT	F	G	H NPT	J NPT	K	L	M	N	P
1½/32 (29.3)	3¹³/₃₂ (186.5)	¾	¾	¾	2¹³/₁₆ (71)	5³/₈ (137)	2½	¼	2³/₆₄ (51.9)	3⁵/₈ (92)	8⁵/₃₂ (207)	9¹¹/₁₆ (246.6)	5½ (140)

Ordering Information

Model Number	Part Number	Description	Weight lbs. (kg)
767	153700	Low water cut-off	8.5 (3.9)

Low Water Cut-Offs – Mechanical For Steam Boilers

Series 69

Built-in Low Water Cut-Offs

- For residential and commercial low pressure steam boiler applications
- For boilers of any steaming capacity
- For mounting in 2½" NPT boiler side tapplings
- Insertion lengths available in 1⅜" - 4⅛" (30-105mm)
- Packless bellows
- Adjustable BX outlet for easy installation
- Dual precision switches for dependable operation of the low water cut-off and an alarm or electric water feeder
- Optional low voltage switches for self-generating millivolt circuits
- Maximum steam pressure 20 psi (1.4 kg/cm²)



Series 69

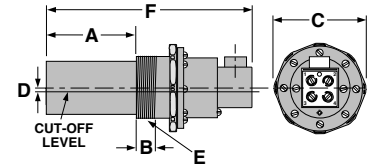

Electrical Ratings

Voltage	Motor Switch Rating (Amperes)		Pilot Duty
	Full Load	Locked Rotor	
120 VAC	7.4	44.4	125 VA at 120 or 240 VAC
240 VAC	3.7	22.2	

Dimensions, in. (mm)

Model	A	B	C	D	E	F
	Insertion Length					
69	4⅛ (105)	1 (25)	4⅛ (105)	⅛ (3)	2½	9½ (241)
169	3⅛ (79)					
269	2¼ (57)					
369	1¾ (45)					
469, 569	1⅜ (30)					

Ordering Information

Model Number	Part Number	Description	Weight lbs. (kg)
69	153900	Low water cut-off w/4⅛" (105mm) insertion length	3.7 (1.7)
69-MV-P	155000	69 w/millivolt switch	4.0 (1.8)
169	155100	69 w/3⅛" (79mm) insertion length	4.0 (1.8)
269	155200	69 w/2¼" (57mm) insertion length	4.0 (1.8)
369	155300	69 w/1¾" (45mm) insertion length	4.0 (1.8)
369-MV	155400	369 w/millivolt switch	4.0 (1.8)
469	155500	69 w/1⅜" (30mm) insertion length	4.0 (1.8)
569	155700	469 w/1⅜" (30mm) insertion length w/¼" NPT tapping	4.0 (1.8)

Low Water Cut-Offs Combination Low Water Cut-Off/Pump Controllers for Steam Boilers

Series 42S Low Water Cut-Off/Pump Controllers



- For residential, commercial, and industrial low and medium pressure steam boilers with a separate water column
- For boilers of any steaming capacity
- Monel bellows provides corrosion resistance
- Single pole, single throw snap action switches
- Enclosed junction box protects switches
- Optional features
 - Quick hook-up fittings
 - Gauge glass connector
- Maximum pressure 50 psi (3.5 kg/cm²)



SERIES 42S

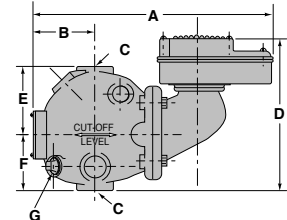

Electrical Ratings

Voltage	Pump Circuit Rating (Amperes)		Pilot Duty
	Full Load	Locked Rotor	
120 VAC	7.4	44.4	345 VA at 120 or 240 VAC
240 VAC	3.7	22.2	

Alarm Circuit Rating (Amperes)	
Voltage	Amps
120 VAC	1
240 VAC	1/2



MODEL 42S-A

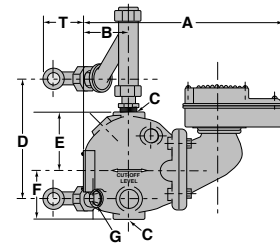

Ordering Information

Model Number	Part Number	Description	Weight lbs. (kg)
42S	129302	Combination low water cut-off/pump controller	15.5 (7.0)
42S-A	129702	42S w/quick hook-up fittings	21.3 (9.7)
42S-N	129802	42S w/glass connector	21.3 (9.7)



MODEL 42S-N

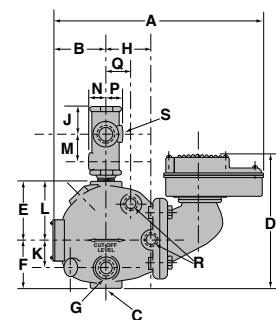

Dimensions, in. (mm)

Model	A	B	C NPT	D	E	F	G NPT
42S	12¼ (311)	2 ⁹ / ₁₆ (65)	1	8 ⁷ / ₈ (225)	3 ¹¹ / ₁₆ (94)	3 ¹ / ₈ (79)	½
42S-A	12¼ (311)	2 ⁹ / ₁₆ (65)	1	7¼-16 ¹¹ / ₁₆ (184-347)	2 ³ / ₄ (45)	3 ¹ / ₈ (79)	½
42S-N	12¼ (311)	2 ⁹ / ₁₆ (65)	1	8 ⁷ / ₈ (225)	3 ¹¹ / ₁₆ (94)	3 ¹ / ₈ (79)	½

Model	H	J	K	L	M	N	P	Q	R NPT	S NPT	T
42S-N	2 ⁹ / ₁₆ (65)	2 ⁹ / ₁₆ (65)	1¾ (45)	3 ¹¹ / ₁₆ (94)	1 ¹³ / ₁₆ (46)	1 ¹ / ₁₆ (27)	1 ¹ / ₁₆ (27)	1½ (38)	¾	¼	2 ⁵ / ₈ (67)

Low Water Cut-Offs – Mechanical For Steam Boilers

Series 150S Low Water Cut-Off/Pump Controllers

- For commercial and industrial low or high pressure boiler applications
- For boilers of any steaming capacity
- Monel bellows provides corrosion resistance
- Snap action switches for high temperature service
 - 1 Single pole, single throw switch for pump control
 - 1 Single pole, double throw switch for low water cut-off and alarm actuation
- Optional features
 - Manual reset
 - 2 Single pole, single throw switches
 - 2 Single pole, double throw switches
 - Float block
 - BSPT threads
- Maximum pressure 150 psi (10.5 kg/cm²)



Series 150S

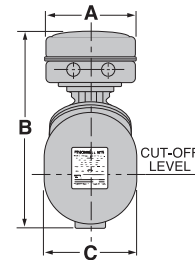
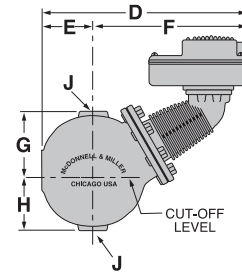

Model 150S-MD

Maximum differential operation

- Prevents nuisance burner shutdowns in **low pressure** applications operating less than 50 psi (3.5 kg/cm²)
- For additional information see page 46

Electrical Ratings

Voltage	Pump Circuit Rating (Amperes)		Pilot Duty
	Full Load	Locked Rotor	
120 VAC	7.4	44.4	345 VA at 120 or 240 VAC
240 VAC	3.7	22.2	

Alarm Circuit Rating (Amperes)	
Voltage	Amps
120 VAC	1
240 VAC	1/2

Ordering Information

Model Number	Part Number	Description	Weight lbs. (kg)
150S	171702	Combination low water cut-off/pump controller	24.7 (11.2)
150S-B	171903	150S w/float block	24.7 (11.2)
150S-B-M	172803	150S-B w/manual reset	24.7 (11.2)
150S-BMD	172002	150S w/float block and max. dif.	24.7 (11.2)
150S-BM-MD	172805	150S-BMD w/manual reset	24.7 (11.2)
150S-MD	171802	150S w/maximum differential	24.7 (11.2)
150S-M	172806	150S w/manual reset	24.7 (11.2)
150S-M-MD	172807	150S-M w/maximum differential	24.7 (11.2)
158S	178402	150S w/2 SPDT switches	26.3 (11.9)
158S-M	172819	158S w/manual reset	27.3 (12.4)
159S	178802	150S w/2 SPST switches	26.0 (11.8)

Dimensions, in. (mm)

A	B	C	D	
5 ⁷ / ₈ (149)	12 ⁷ / ₁₆ (316)	6 (152)	13 ¹ / ₄ (337)	
E	F	G	H	J
3 ⁵ / ₁₆ (84)	9 ¹⁵ / ₁₆ (252)	4 ¹ / ₈ (107.5)	3 ⁷ / ₁₆ (91.5)	1 NPT

Low Water Cut-Offs – Mechanical For Steam Boilers

Series 157S

Low Water Cut-Off/Pump Controllers

- For residential, commercial and industrial low or high pressure boiler applications
- For boilers of any steaming capacity
- Monel bellows provides corrosion resistance
- Float chamber with integral water column provided
- Snap action for high temperature service
 - 1 Single pole, single throw switch for pump control
 - 1 Single pole, double throw switch for low water cut-off and alarm actuation
- Optional features
 - Manual reset
 - Integral conductance probes for additional levels and greater operating differential-Model 157S-RBP-MD
 - 1" or 1 1/4" NPT equalizing tappings
 - 1/2" or 3/4" NPT tappings for gauge glass/tri-cock installations
 - BSPT threads
- Maximum pressure 150 psi (10.5 kg/cm²)



Series 157S

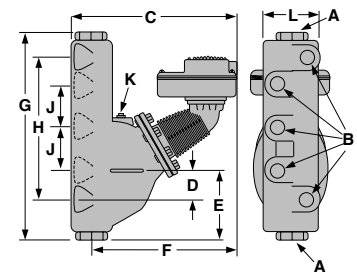

Model 157S-R

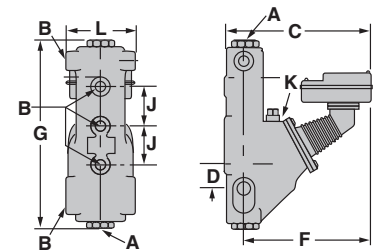

Model 157S-MD

Maximum differential operation

- Prevents nuisance burner shutdowns in **low pressure** applications operating less than 50 psi (3.5 kg/cm²)
- For additional information see page 46

Electrical Ratings

Voltage	Cut-off and Pump Circuits Rating (Amperes)		Pilot Duty
	Full Load	Locked Rotor	
120 VAC	7.4	44.4	345 VA at 120 or 240 VAC
240 VAC	3.7	22.2	

Alarm Circuit Rating (Amperes)	
Voltage	Amps
120 VAC	1
240 VAC	1/2

Dimensions, in. (mm)

Model	A NPT	B NPT	C	D	E	F	G	H	J	K NPT	L
157S	1	1/2	13 3/8 (339)	2 5/16 (59)	4 15/16 (125)	11 3/4 (298)	16 (406)	11 1/2 (292)	3 1/2 (89)	3/4	5 7/8 (149)
157S-A	1 1/4	3/4	13 3/8 (339)	2 5/16 (59)	4 15/16 (125)	11 3/4 (298)	16 (406)	11 1/2 (292)	3 1/2 (89)	3/4	5 7/8 (149)
157S-R	1	1/2	13 3/8 (339)	2 1/4 (57)	5 7/8 (149)	11 3/4 (298)	17 (432)	11 1/2 (292)	3 1/2 (89)	3/4	6 1/4 (159)
157S-RL	1 1/4	1/2	13 3/8 (345)	3 1/2 (89)	5 7/8 (149)	11 3/4 (298)	17 (432)	12 3/4 (324)	3 1/2 (89)	3/4	6 1/4 (159)

Ordering Information

Model Number	Part Number	Description	Weight lbs. (kg)
157S	173502	150S low water cut-off w/water column	39.7 (18.0)
157S-MD	173603	157S w/maximum differential	39.7 (18.0)
157S-A	173702	157S w/alternate tappings	39.5 (17.9)
157S-A-M	172811	157S-A w/manual reset	39.5 (17.9)
157S-M	172812	157S w/manual reset	39.7 (18.0)
157S-M-MD	172813	157S-M w/maximum differential	39.7 (18.0)
157S-R	176220	157S w/alternate tappings	42.0 (19.0)
157S-R-M	172817	157S-R w/manual reset	42.0 (19.0)
157S-RBP-MD	176503	157S w/2 integral conductance probes	51.0 (23.1)
157S-RL	176902	157S w/alternate tappings	42.0 (19.0)
157S-RL-M	172815	157S-RL w/manual reset	42.0 (19.0)

MD Model Setpoints

The bellows on the 150 units are sensitive to pressure. At higher pressures the bellows is stiffer requiring more force to move it. At lower pressures the bellows is more pliable (less stiff) requiring less force to move it. Consequently, the on/off points tend to narrow at lower pressures. (Less distance between on and off).

Early versions of the 150 units with mercury bulb switches were able to be adjusted. These units had knurled adjustment screws that could be used to raise, lower or widen the setpoints. Although the available adjustment was small (usually $\frac{1}{16}$ " to $\frac{1}{8}$ " total), it was enough to compensate in the field for lower pressure systems.

Later versions of the 150 with mercury bulb switches and all snap switch units are not adjustable in the field. The 'MD' models were created to provide a 150 control with factory settings to compensate for the narrowing of setpoints on new and existing installations.

On 'MD' models the distance between pump off and burner off is increased by approximately $\frac{7}{16}$ ". Note that the pump on/off differential on both standard and 'MD' models is set at $\frac{3}{4}$ "

This larger differential is accomplished by lowering the burner off setpoint $\frac{3}{8}$ " below the casting line on 'MD' models when setting the burner on/off points at 150 psi. This compensates for the narrowing of the setpoints at lower operating pressures because the burner off point will move upward (closer to the casting line) at lower pressures.

Operating Levels
Series 150/157 & Series 150S/157S

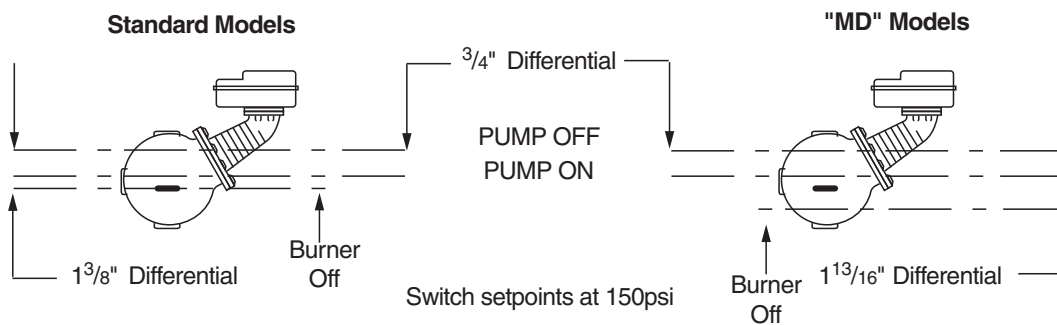

Low Water Cut-Offs – Mechanical For Steam Boilers

Series 1575

Low Water Cut-Off/Pump Controllers

- Primary low water fuel cut-off protection and pump control for commercial and industrial steam boilers
- Motorized valve controller, low water cut-off and alarm actuator for boilers, vessels and tanks
- Set points and differential remain constant throughout pressure range
- Diagnostic features incorporated in the control include:
 - High ambient temperature protection
 - Internal LEDs that indicate water position and condition
 - External LEDs that indicate control activity
- Adjustable pump differentials by cutting probes to desired set points
- Control unit mounted remotely from probe chamber for maximum flexibility
- Adjustable 60-second burner-off time delay
- 1 HP burner and pump relays
- Solid state operation
- Redundant low-water and pump-off circuitry
- 60,000 ohms probe sensitivity
- Test button to quickly confirm proper operation
- Probe chamber with 3 probes and gauge glass tapplings
- 4th probe can be added for high water control
- NEMA1 electrical control unit enclosure
- NEMA4X probe chamber enclosure
- Maximum ambient temperature 135°F (57°C)
- Maximum water temperature 406°F (208°C) at probes
- Maximum water pressure of 250 psi (17.6 kg/cm²)



Probe Chamber
(with 3 probes standard)

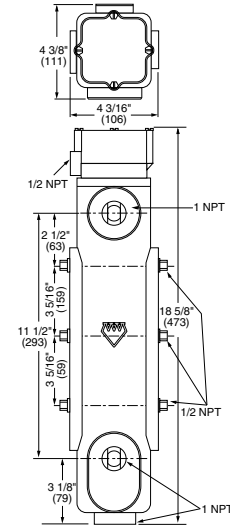

Electrical Control Unit
(for remote mounting)

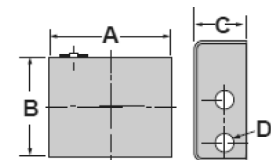

Dimensions, in. (mm)

Probe Chamber

A	B	C	D	E	F	G	H	J
18 ⁵ / ₈ (473)	11 ¹ / ₂ (292)	3 ¹ / ₈ (79)	2 ¹ / ₂ (64)	3 ¹ / ₄ (82)	4 ³ / ₈ (111)	4 ³ / ₁₆ (106)	1 NPT	1 NPT
							1	1

Electrical Control Unit

A	B	C	D
6 ¹ / ₂ (159)	5 ³ / ₁₆ (132)	2 ³ / ₄ (70)	3 ¹ / ₄ (20)

Electrical Rating and Switch Ratings

Supply Voltage	Probe Voltage	Full load (Amps) NO (NC), (VAC)	Locked Rotor (Amps) NO (NC), (VAC)	Pilot Duty (VA) NO (NC), (VAC)	Motor (HP) NO (NC), (VAC)
120 VAC	5 VAC	16 (5.8), 120	96 (34.8), 120	470 (290), 120	1 (1/4), 120
50/60Hz	Maximum	8 (4.9), 240	48 (17.4), 240	470 (290), 240	2 (1/2), 240

Ordering Information

Model Number	Part Number	Description
1575	171907	Combination LWCO/pump controller

Low Water Cut-Offs – Mechanical Combination Low Water Cut-Off/Pump Controllers for Steam Boilers

Series 93 Low Water Cut-Off/Pump Controllers



- For commercial and industrial low or high pressure steam boilers
- Maintains consistent water level regardless of pressure
- For boilers of any steaming capacity
- No. 5 Switch included
- Magnetic repulsion eliminates need for bellows
- Optional features
 - Manual reset
- 7B switch (135ohm proportional control signal) to maintain constant boiler water level
- 1" NPT connections
- Maximum pressure 150 psi (10.5 kg/cm²)



SERIES 93

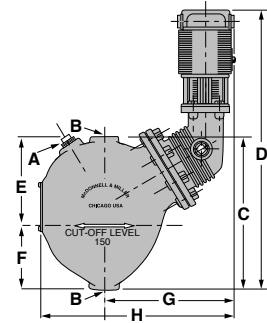

Electrical Ratings

345 VA at 120 or 240 VAC

Dimensions, in. (mm)

A NPT	B NPT	C	D	E	F	G	H
3/4	1	10 1/16 (256)	18 5/8 (473)	5 19/32 (142)	4 15/32 (113.5)	8 7/8 (225)	12 7/8 (327)

Ordering Information

Model Number	Part Number	Description	Weight lbs. (kg)
93	162300	Combination low water cut-off/pump controller w/No. 5 switch	35.0 (15.9)
93-M	162500	93 w/manual reset	35.0 (15.9)
93-7B	163000	93 w/No. 7B switch	35.5 (16.0)
93-7B-M	163100	93-7B W/manual reset	35.5 (16.0)

Low Water Cut-Offs – Mechanical Combination Low Water Cut-Off/Pump Controllers for Steam Boilers

Series 193 Low Water Cut-Off/Pump Controllers

- For commercial and industrial low or high pressure steam boilers
- Maintains consistent water level regardless of pressure
- Water column with integral tapplings for gauge glass and tri-cock installations
- For boilers of any steaming capacity
- No. 5 Switch included
- Magnetic repulsion eliminates need for bellows
- Optional features
 - Manual reset
- 7B switch (135ohm proportional control signal) to maintain constant boiler water level
- 1" NPT connections
- Maximum pressure 150 psi (10.5 kg/cm²)

Electrical Ratings

345 VA at 120 or 240 VAC

Dimensions, in. (mm)

Model	A NPT	B NPT	C NPT	D NPT	E NPT	F NPT	G NPT	H NPT	J NPT	K NPT
193	1	1/2	1/2	1/2	–	–	1/2	1/2	1/2	3/4
193-A	1	1/2	1/2	1/2	1/2	1/2	–	–	1/2	3/4
193-B	1 1/4	3/4	3/4	3/4	–	–	3/4	3/4	1/2	3/4
193-D	1	1/2	1	1/2	1	1/2	–	–	1/2	3/4
193-G	1	1/2	–	1/2	1	1/2	–	–	1/2	3/4

Model	L	M	N	P	Q	R
193	12 3/4 (324)	–	10 13/16 (274)	13 (330)	–	2 7/8 (73)
193-A	–	11 1/2 (292)	10 13/16 (274)	13 (330)	2 1/4 (57)	–
193-B	12 3/4 (324)	–	10 13/16 (274)	13 (330)	–	2 7/8 (73)
193-D	–	11 1/2 (292)	10 13/16 (274)	13 (330)	2 1/4 (57)	–
193-G	–	11 1/2 (292)	10 13/16 (274)	13 (330)	2 1/4 (57)	–

Model	S	T	U	V	W	X
193	6 3/4 (171.4)	17 1/2 (445)	20 1/2 (521)	3 1/2 (89)	3 1/2 (89)	6 (152)
193-A	6 3/4 (171.4)	17 1/2 (445)	20 1/2 (521)	3 1/2 (89)	3 1/2 (89)	6 (152)
193-B	6 3/4 (171.4)	17 1/2 (445)	20 1/2 (521)	3 1/2 (89)	3 1/2 (89)	6 (152)
193-D	6 3/4 (171.4)	17 1/2 (445)	20 1/2 (521)	3 1/2 (89)	3 1/2 (89)	6 (152)
193-G	6 3/4 (171.4)	17 1/2 (445)	20 1/2 (521)	3 1/2 (89)	3 1/2 (89)	6 (152)



SERIES 193

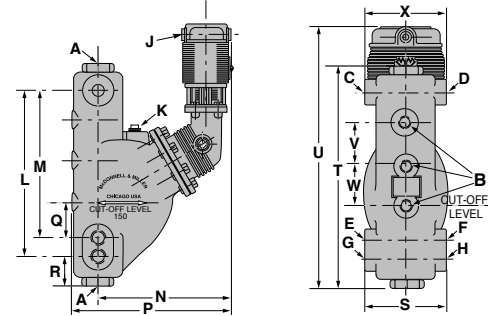

Ordering Information

Model Number	Part Number	Description	Weight lbs. (kg)
193	163400	Combination low water cut-off/pump controller w/No. 5 switch	52.5 (23.8)
193-A	163500	193 w/alternate tapplings	52.5 (23.8)
193-A-7B	164500	193-A w/No. 7B switch	52.5 (23.8)
193-A-7BM	164600	193-A-7B w/manual reset	52.5 (23.8)
193-A-M	164200	193-A w/manual reset	52.5 (23.8)
193-B	163600	193 w/alternate tapplings	52.5 (23.8)
193-B-M	164300	193-B w/manual reset	52.5 (23.8)
193-B-7B	164700	193-B w/No. 7B switch	52.5 (23.8)
193-D	163900	193 w/alternate tapplings	52.5 (23.8)
193-D-7B	163903	193-D w/No. 7B switch	52.5 (23.8)
193-M	164100	193 w/manual reset	52.5 (23.8)
193-7B	164400	193 w/No. 7B switch	52.5 (23.8)
193-7BM	164525	193-7B w/manual reset	52.5 (23.8)
193-D-M	163902	193-D w/manual reset	52.5 (23.8)
193-G	164760	193 w/alternate tapplings	52.5 (23.8)

Low Water Cut-Offs – Mechanical Combination Low Water Cut-Off/Pump Controllers for Steam Boilers

Series 94

Low Water Cut-Off/Pump Controllers

- For commercial and industrial low or high pressure steam boilers
- Maintains consistent water level regardless of pressure
- For boilers of any steaming capacity
- No. 5 Switch included
- Magnetic repulsion eliminates need for bellows
- Optional features
 - Manual reset
- 7B switch (135ohm proportional control signal) to maintain constant boiler water level
 - BSPT threads
- 1¼" NPT connections
- Maximum pressure 250 psi (17.6 kg/cm²)
- Ten bolt flange

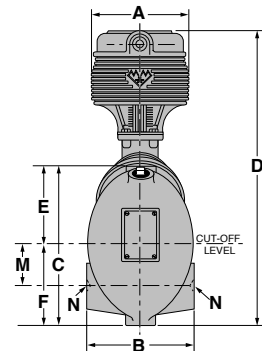
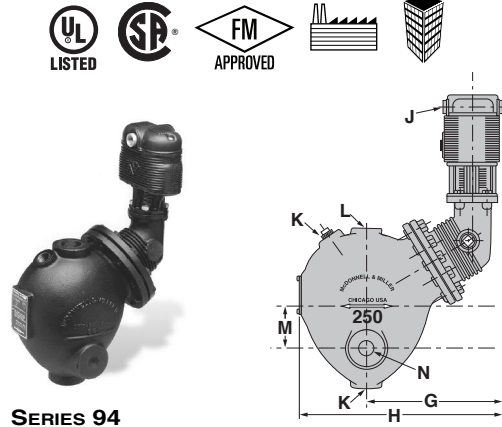

Electrical Ratings

345 VA at 120 or 240 VAC

Ordering Information

Model Number	Part Number	Description	Weight lbs. (kg)
94	165200	Combination low water cut-off/pump controller w/No. 5 switch	52.5 (23.8)
94-A	165500	94 w/alternate tapplings	50.3 (22.8)
94-AM	165800	94-A w/manual reset	50.3 (22.8)
94-A-7B	165700	94-AM w/No. 7B switch	52.5 (23.8)
94-M	165900	94 w/manual reset	52.5 (23.8)
94-7B	166300	94 w/No. 7B switch	52.0 (23.6)

Dimensions, in. (mm)

Model	A	B	C	D
94	6 (152)	7 (178)	10 ⁹ / ₁₆ (268)	18 ¹³ / ₁₆ (478)
94-A	6 (152)	7 (178)	10 ⁹ / ₁₆ (268)	18 ¹³ / ₁₆ (478)

Model	E	F	G	H
94	5 ⁷ / ₈ (149)	4 ¹¹ / ₁₆ (119)	8 ³ / ₄ (222)	12 ¹⁵ / ₁₆ (328.6)
94-A	5 ⁷ / ₈ (149)	4 ¹¹ / ₁₆ (119)	8 ³ / ₄ (222)	12 ¹⁵ / ₁₆ (328.6)

Model	J	K NPT	L NPT	M	N
94	½ (15)	1¼	1¼	–	–
94-A	½ (15)	1¼	1¼	2 ¹ / ₁₆ (52)	1¼ (32)

Low Water Cut-Offs – Mechanical Combination Low Water Cut-Off/Pump Controllers for Steam Boilers

Series 194

Low Water Cut-Off/Pump Controllers

- For commercial, and industrial low or high pressure steam boilers
- Maintains consistent water level regardless of pressure
- For boilers of any steaming capacity
- Water column with integral tapplings for gauge glass and tri-cock installations
- No. 5 Switch included
- Magnetic repulsion eliminates need for bellows
- Optional features
 - Manual reset
- 7B switch (135 ohm proportional signal) control to maintain constant boiler water level
- 1¼" NPT connections
- Maximum pressure 250 psi (17.6 kg/cm²)
- Ten bolt flange



SERIES 194

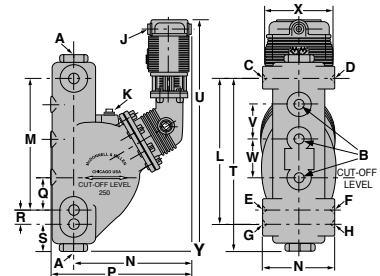

Electrical Ratings

345 VA at 120 or 240 VAC

Ordering Information

Model Number	Part Number	Description	Weight lbs. (kg)
194	166600	Combination low water cut-off/pump controller w/Series 5 switch	72.0 (32.7)
194-A	166700	194 w/alternate tapplings	72.0 (32.7)
194-A-7B	167100	194-A w/Series 7B switch	72.0 (32.7)
194-M	166900	194 w/manual reset	72.0 (32.7)
194-7B	167200	194 w/Series 7B switch	72.0 (32.7)
194-7BM	167300	194-7B w/manual reset	72.0 (32.7)
194-B	166701	194 w/alternate tapplings	72.0 (32.7)

Dimensions, in. (mm)

Model	A NPT	B NPT	C NPT	D NPT	E NPT	F NPT	G NPT	H NPT	J NPT	K NPT
194	1¼	½	½	½	½	½	–	–	½	¾
194-A	1¼	½	½	½	–	–	½	½	½	¾
194-B	1¼	¾	¾	¾	–	–	¾	¾	½	¾

Model	L	M	N	P	Q	R	S
194	–	11 ⁵ / ₈ (295)	6 ³ / ₄ (171.4)	13 ¹ / ₁₆ (332)	2 ¹³ / ₁₆ (71)	1¼ (32)	2 ³ / ₈ (60)
194-A	12 ⁷ / ₈ (327)	–	6 ³ / ₄ (171.4)	13 ¹ / ₁₆ (332)	2 ¹³ / ₁₆ (71)	1¼ (32)	2 ³ / ₈ (60)
194-B	12 ⁷ / ₈ (327)	–	6 ³ / ₄ (171.4)	13 ¹ / ₁₆ (332)	2 ¹³ / ₁₆ (71)	1¼ (32)	2 ³ / ₈ (60)

Model	T	U	V	W	X	Y
194	17¼ (438)	20½ (521)	3 (76)	3 (76)	6 (152)	10 ¹³ / ₁₆ (274)
194-A	17¼ (438)	20½ (521)	3 (76)	3 (76)	6 (152)	10 ¹³ / ₁₆ (274)
194-B	17¼ (438)	20½ (521)	3 (76)	3 (76)	6 (152)	10 ¹³ / ₁₆ (274)

Water Feeders – Electronic

Series WFE Uni-Match®



- Field-adjustable dwell-feed cycles
- Multi-Color LED status indicator
- Manual feed button
- Hard-stop limit to minimize chances of flooding the boiler
- Compatible with all electronic & mechanical Low Water Cut-Offs
- Includes adapters for connection to 1/2" copper tubing
- Removable strainer (replace after cleaning)
- Maximum water pressure 150 psi (10.5 kg/cm²)
- Maximum boiler pressure 15 psi (1 kg/cm²)
- Maximum water temperature 120°F (49°C)
- Maximum ambient temperature 100°F (38°C)
- Maximum power consumption (during water feed only)
 - 15 VA at 24 VAC
 - 20 VA at 120 VAC (50 or 60 Hz)



Series WFE

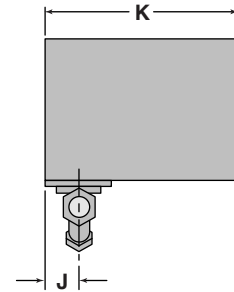
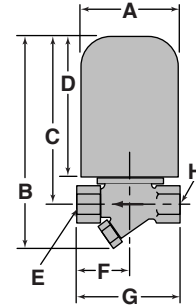

Dimensions, in. (mm)

A	B	C	D	E NPT	F	G	H NPT	J	K
2 7/8 (73)	6 1/4 (159)	4 7/8 (124)	4 1/4 (108)	3/8	1 17/32 (39)	3 1/16 (78)	3/8	1 1/32 (26)	5 13/16 (148)

Ordering Information

Model Number	Part Number	Description	Weight lbs. (kg)
WFE-24	169550	Electric Water Feeder, 24V	2.8 (1.3)
WFE-120	169560	Electric Water Feeder, 120V	2.8 (1.3)

Water Feeders – Electric

Series 101-A Electric Water Feeders



- For low pressure steam boilers with **cold water feed**
- Eliminates necessity to manually add water to the boiler
- Can be used with mechanical or electronic low water cut-off controls
- Quick-change replaceable cartridge valve and strainer
- Manual feed button
- Model 101-A features a 120 VAC solenoid
- Model 101-A-24 features a 24 VAC solenoid and a separate 50VA transformer
- Maximum water supply pressure 150 psi (10.5 kg/cm²)
- Maximum boiler pressure 25 psi (1.8 kg/cm²)
- Maximum inlet water temperature 120°F (49°C)
- Maximum power consumption
 - 40 VA at 24 VAC
 - 40 VA at 120 VAC

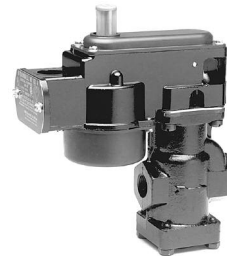

Series 101-A

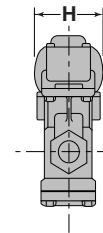
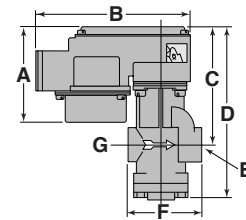

Flow Data

Pressure Differential psi (kg/cm ²)		Flow Rate gpm (lpm)	
5	(.4)	1.4	(5.3)
10	(.7)	1.7	(6.4)
20	(1.4)	2.1	(7.9)
40	(2.8)	2.9	(11.0)
60	(4.2)	3.4	(12.9)
80	(5.6)	4.0	(15.1)

Dimensions, in. (mm)

A	B	C	D	E NPT	F	G NPT	H
4 ¹ / ₁₆ (103)	6 ⁷ / ₈ (175)	5 ¹ / ₈ (130)	7 ⁹ / ₁₆ (192)	1/2	3 ⁵ / ₁₆	1/2	3 (76)

Ordering Information

Model Number	Part Number	Description	Weight lbs. (kg)
101A	169400	Electric water feeder, 120V	2.8 (1.3)
101A-24V	169500	Electric water feeder, 24V	2.8 (1.3)

Water Feeders – Mechanical

Series 47/47-2 Mechanical Water Feeders/Low Water Cut-Offs



- For steam and hot water boilers with **cold water feed**
- Continuous maintenance of **minimum safe water level**, independent of electrical service
- Proportional feed action
- Quick hook-up fittings provided
- Quick-change replaceable cartridge valve and strainer
- Optional features
 - No. 2 switch
 - Manual reset
- Model 47 can be field upgraded with a No. 2 switch to add low water cut-off function
- Maximum water supply pressure 150 psi (10.5 kg/cm²)
- Maximum inlet water temperature 120°F (49°C)
- Maximum boiler pressure 25 psi (1.8 kg/cm²)



Series 47

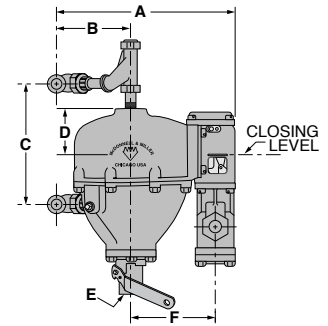

Series 47-2

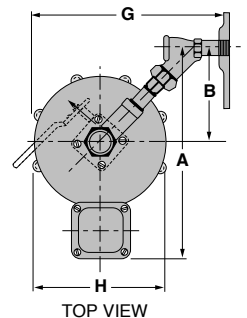
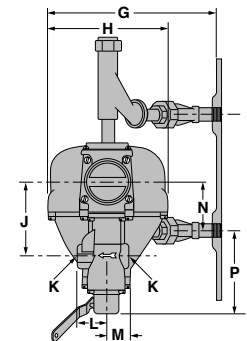
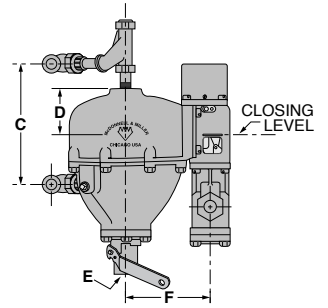

Electrical Ratings

Voltage	Motor Switch Rating (Amperes)		Pilot Duty
	Full Load	Locked Rotor	
120 VAC	10.2	61.2	125 VA at 120 or 240 VAC 60 Hz
240 VAC	5.1	30.6	

Dimensions, in. (mm)

A	B	C	D	E NPT	F	G
11 ⁷ / ₈ (302)	5 ¹ / ₄ (133)	7 ³ / ₈ (187) min. 14 (356) max.	2 ⁵ / ₈ (67)	³ / ₄	5 ¹ / ₈ (130)	10 ⁵ / ₈ (270)
H	J	K NPT	L	M	N	P
7 ⁵ / ₁₆ (186)	4 ⁵ / ₈ (117)	¹ / ₂	1 ²⁹ / ₃₂ (58.4)	1 ¹³ / ₃₂ (35.7)	3 (76)	5 ⁵ / ₁₆ (135)

Water Feeders – Mechanical

Series 47 (continued) Mechanical Water Feeders

Capacities

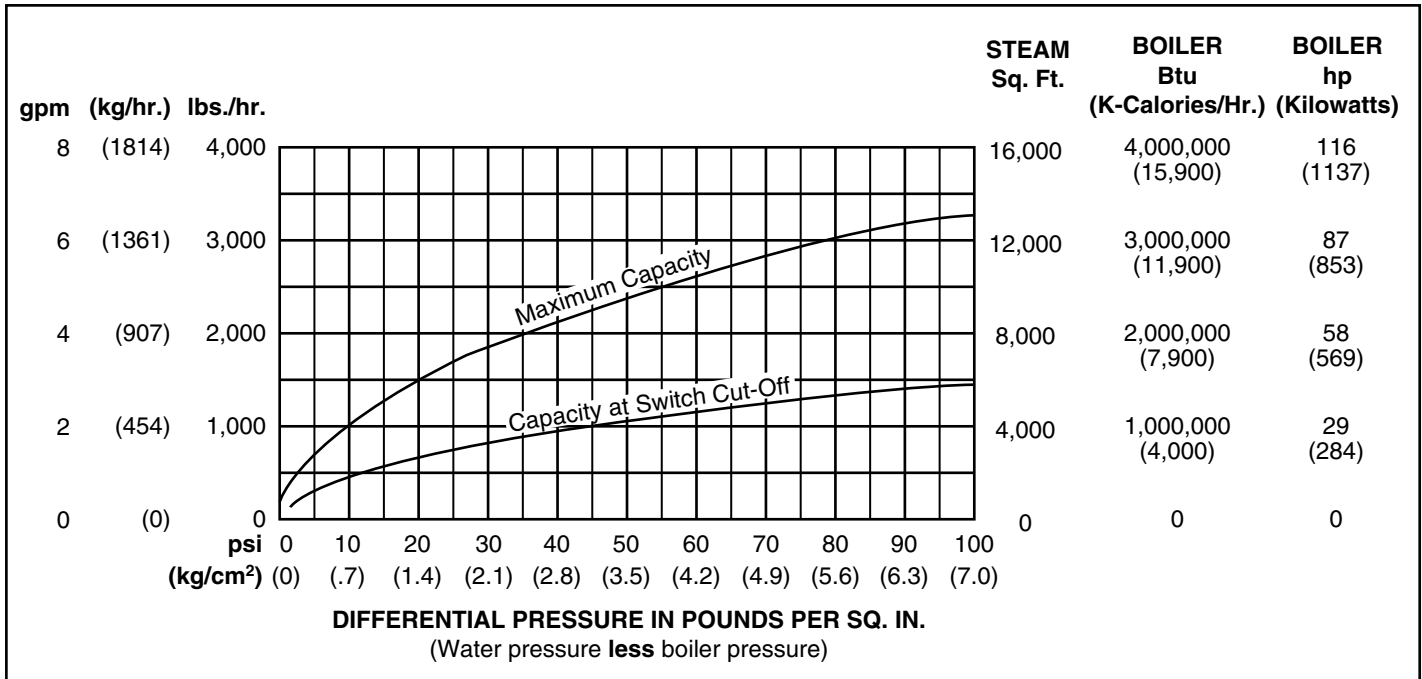

Ordering Information

Model Number	Part Number	Description	Weight lbs. (kg)
47	132700	Mechanical water feeder	27.5 (12.5)
47-2	132800	47 w/No. 2 switch	28.5 (13.0)
47-2-M	132900	47-2 w/manual reset	28.5 (13.0)
47-X	133400	47 w/o quick hook-up fittings	25.0 (11.4)
47-2X	176212	47-2 w/o quick hook-up fittings	26.0 (11.8)

Water Feeders – Mechanical

Series 247/247-2 Mechanical Water Feeders/Low Water Cut-Offs



- For steam and hot water boilers with **cold water feed**
- Continuous maintenance of **minimum safe water level**, independent of electrical service
- Proportional feed action
- Quick-change replaceable cartridge valve and strainer
- Quiet, durable operation
- Isolated feed valve minimizes lime and scale build-up
- Optional features
 - No. 2 switch
 - Manual reset
- Model 247 can be field upgraded with a No. 2 switch to add low water cut-off function
- Maximum water supply pressure 150 psi (10.5 kg/cm²)
- Maximum inlet water temperature 120°F (49°C)
- Maximum vessel pressure 30 psi (2.1 kg/cm²)



Series 247

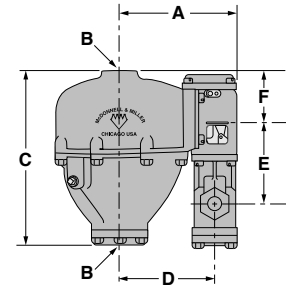

Series 247-2

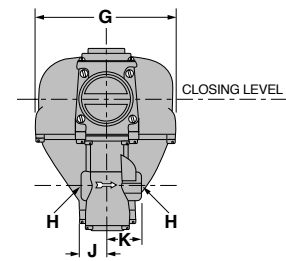
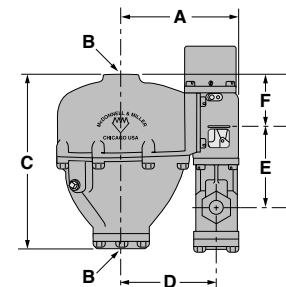

Electrical Ratings

Voltage	Motor Switch Rating (Amperes)		Pilot Duty
	Full Load	Locked Rotor	
120 VAC	10.2	61.2	125 VA at 120 or 240 VAC 60 Hz
240 VAC	5.1	30.6	

Dimensions, in. (mm)

A	B NPT	C	D	E	F	G	H NPT	J	K
6½ (165)	1	9⅛ (232)	5⅛ (130)	4⅝ (117)	2⅝ (67)	7⅝ (186)	½	1⅓ (35.7)	1⅔ (48.4)

Water Feeders – Mechanical

Series 247 (continued) Mechanical Water Feeders

Capacities

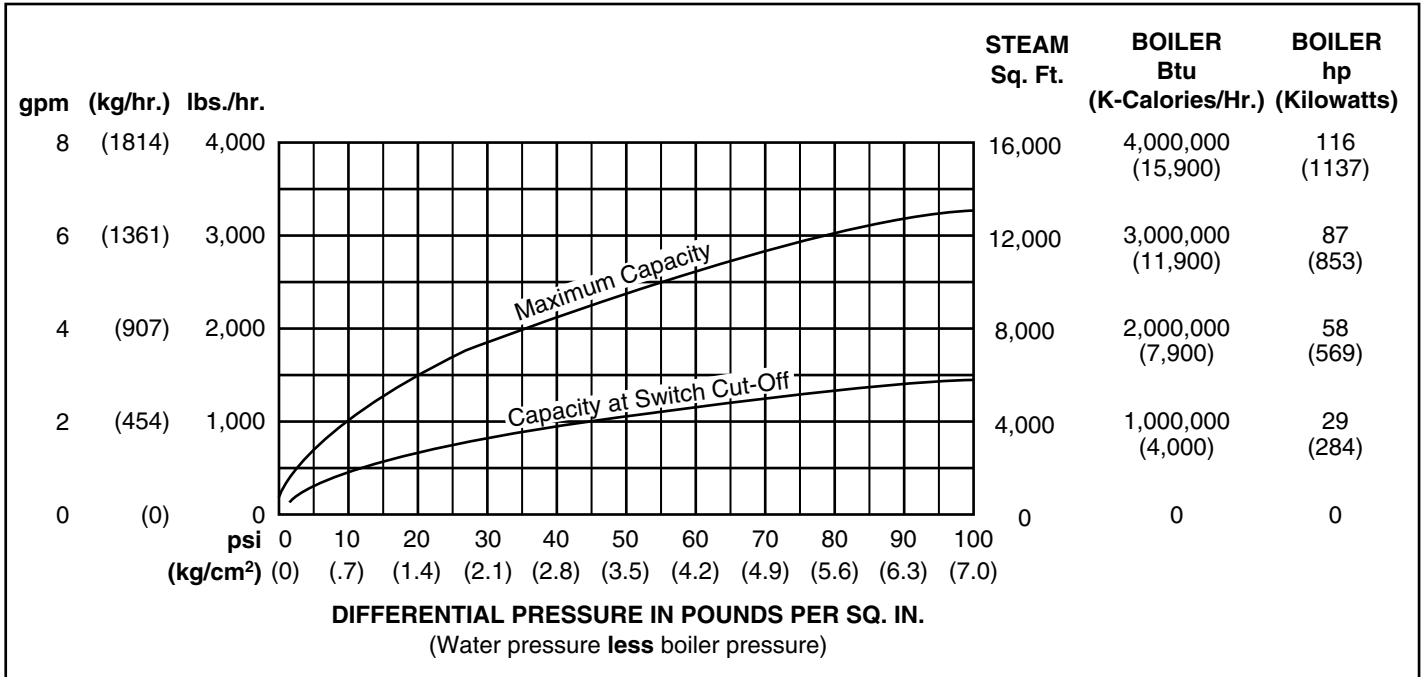

Ordering Information

Model Number	Part Number	Description	Weight lbs. (kg)
247	133700	Mechanical water feeder	22.0 (10.0)
247-2	133800	247 w/No. 2 switch	22.5 (10.2)
247-2-M	133900	247-2 w/manual reset	22.5 (10.2)

Water Feeders – Mechanical

Series 51/51-2 Mechanical Water Feeders/Low Water Cut-Offs

- For low pressure steam and hot water boilers larger than 5,000 sq. ft. (465m²) capacity with **cold water feed**
- Quick-change replaceable cartridge valve and strainer
- Optional features
 - No. 2 switch
 - Manual reset
 - Float block
- Proportional feed action
- Model 51 can be field upgraded with a No. 2 switch to add low water cut-off function
- Maximum water supply pressure 150 psi (10.5 kg/cm²)
- Maximum inlet water temperature 120°F (49°C)
- Maximum vessel pressure 35 psi (2.5 kg/cm²)



Series 51

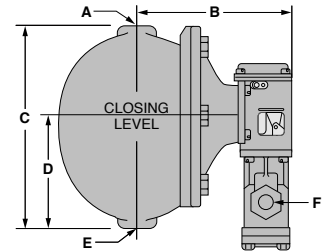

Series 51-2

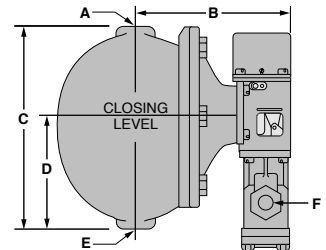

Electrical Ratings

Voltage	Motor Switch Rating (Amperes)		Pilot Duty
	Full Load	Locked Rotor	
120 VAC	10.2	61.2	125 VA at 120 or 240 VAC 60 Hz
240 VAC	5.1	30.6	

Dimensions, in. (mm)

A	B	C	D	E	F
NPT				NPT	NPT
1	8 (203)	10 ³ / ₈ (264)	5 ³ / ₄ (146)	1	³ / ₄

Ordering Information

Model Number	Part Number	Description	Weight lbs. (kg)
51	134700	Mechanical water feeder	35.3 (16.0)
51-B	134800	51 w/float block	38.5 (17.5)
51-B-2	135400	51-B w/Series 2 switch	38.3 (17.4)
51-B-2-M	135500	51-B-2 w/manual reset	38.3 (17.4)
51-2	135000	51 w/Series 2 switch	35.8 (16.2)
51-2-M	135200	51-2 w/manual reset	35.7 (16.2)

Capacities

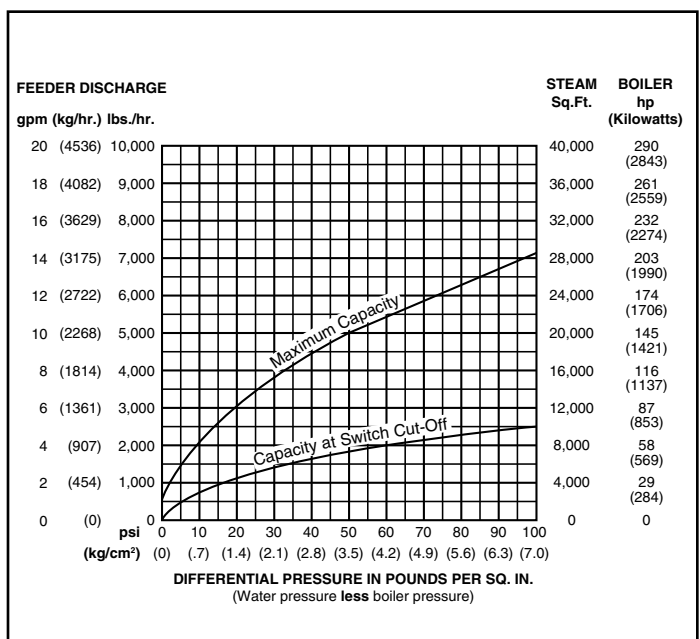

Water Feeders – Mechanical

Series 51-S/51-S-2 Mechanical Water Feeders/Low Water Cut-Offs



- For high capacity [up to 35,000 sq. ft. (3250m²)] low pressure steam and hot water boilers with **cold water feed**
- Optional features
 - No. 2 switch
 - Manual reset
 - Float block
- Proportional feed action
- Maximum water supply pressure 100 psi (7 kg/cm²)
- Maximum inlet water temperature 120°F (49°C)
- Maximum vessel pressure 35 psi (2.5 kg/cm²)



Series 51-S

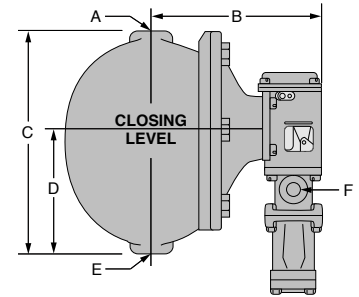

Electrical Ratings

Voltage	Motor Switch Rating (Amperes)		Pilot Duty
	Full Load	Locked Rotor	
120 VAC	10.2	61.2	125 VA at 120 or 240 VAC 60 Hz
240 VAC	5.1	30.6	



Series 51-S-2

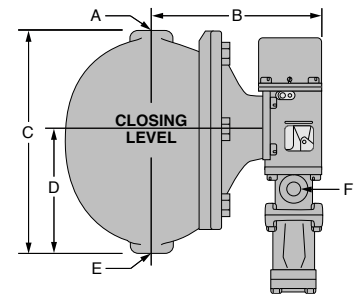

Dimensions, in. (mm)

A	B	C	D	E	F
NPT				NPT	NPT
1	8 ¹ / ₈ (203)	10 ³ / ₈ (264)	5 ³ / ₄ (146)	1	³ / ₄

Ordering Information

Model Number	Part Number	Description	Weight lbs. (kg)
51-S	135600	Mechanical water feeder	36.5 (16.6)
51-S-2	135900	51-S w/No. 2 switch	37.3 (16.9)
51-S-2-M	136000	51-S-2 w/manual reset	37.3 (16.9)
51-SB	135700	51-S w/float block	41.8 (19.0)
51-SB-2	136300	51-SB w/No. 2 switch	41.8 (19.0)
51-SB-2-M	136100	51-SB-2 w/manual reset	43.7 (19.8)

Capacities

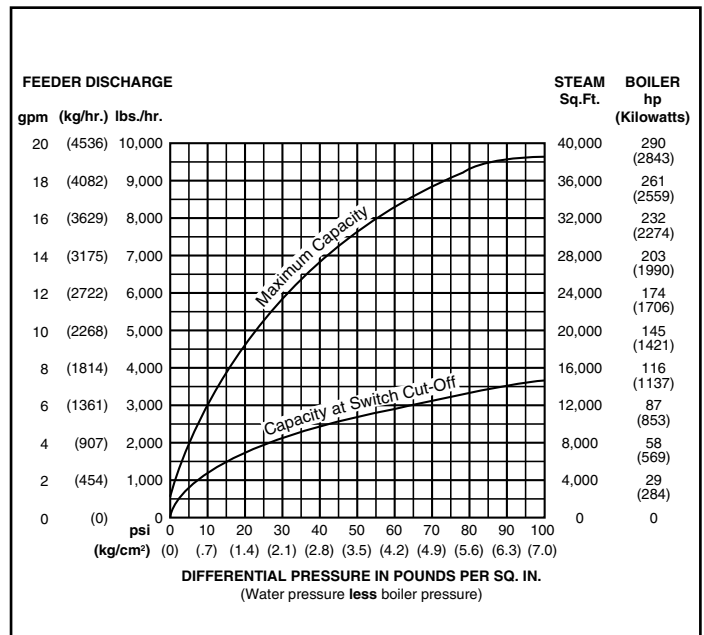

Water Feeders – Mechanical

Series 53/53-2 Mechanical Water Feeders/Low Water Cut-Offs

- For low pressure steam and hot water boilers larger than 5,000 sq. ft. (465m²) with hot or cold water feed
- Optional features
 - No. 2 switch
 - Manual reset
 - Float block
- Proportional feed action
- Model 53 can be field upgraded with a No. 2 switch to add low water cut-off function
- Maximum water supply pressure 150 psi (10.5 kg/cm²)
- Maximum inlet water temperature 120°F (49°C)
- Maximum vessel pressure 75 psi (5.3 kg/cm²)



Series 53

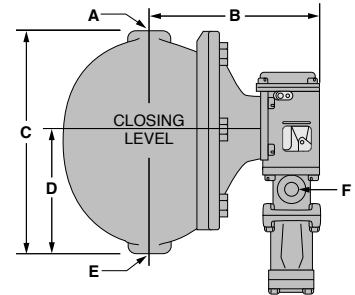

Electrical Ratings

Voltage	Motor Switch Rating (Amperes)		Pilot Duty
	Full Load	Locked Rotor	
120 VAC	10.2	61.2	125 VA at 120 or 240 VAC 60 Hz
240 VAC	5.1	30.6	



Series 53-2

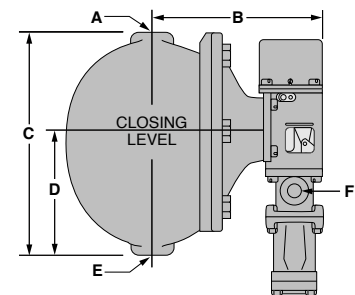

Dimensions, in. (mm)

A	B	C	D	E	F
NPT				NPT	NPT
1	8 ¹ / ₈ (206)	10 ³ / ₈ (264)	5 ³ / ₄ (146)	1	³ / ₄

Ordering Information

Model Number	Part Number	Description	Weight lbs. (kg)
53	136900	Mechanical water feeder	38.0 (17.2)
53-B	137400	53 w/float block	42.0 (19.0)
53-B-2	137500	53-B w/No. 2 switch	42.0 (19.0)
53-B-2-M	137600	53-B w/No. 2 switch & manual reset	42.0 (19.0)
53-2	137100	53 w/No. 2 switch	38.5 (17.5)
53-2-M	137200	53-2 w/manual reset	38.5 (17.5)

Capacities

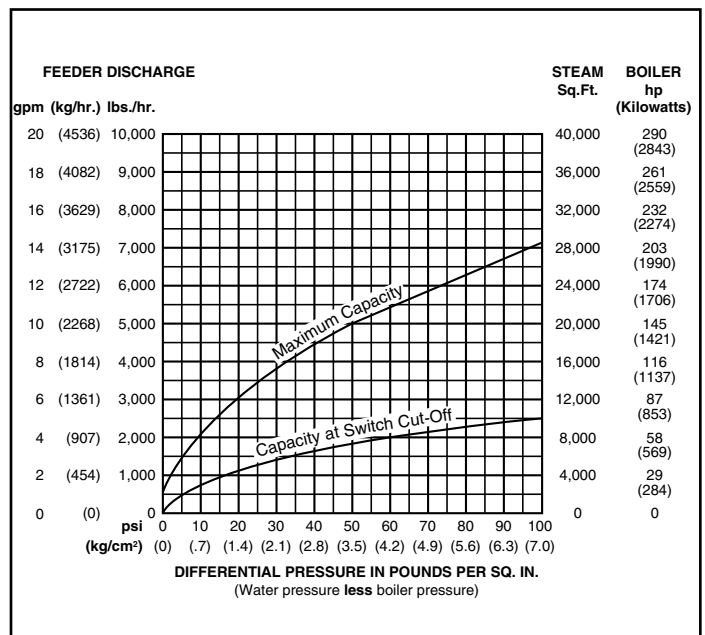

Make-Up Water Feeders

In boiler feed systems with higher pressures, a make-up feeder is usually provided on the condensate receiver. It adds water to the receiver when necessary so there is always an adequate supply for boiler demand.

McDonnell & Miller Make-up feeders provide large feeding capacity. Unless otherwise stated, valves and seats are of stainless steel and protected by a large integral strainer. Positive alignment of the valve is assured by cam & roller, straight thrust action. These feeders can be used for many other liquid control applications such as:

- Pharmaceutical
- Laboratory
- Industrial
- Distillation equipment
- Receiver tanks
- Evaporative coolers
- Humidifiers
- Aquariums
- Steam baths
- Wet and dry hygrometers

Water Feeding Capacity lbs./hr. (kg/hr.)

Model Number	City Water Supply Pressure with 3/4" NPT Pipe and No Tank Pressure, 0 psi (kg/cm ²)								
	10 (.7)	20 (1.4)	30 (2.1)	40 (2.8)	50 (3.5)	60 (4.1)	70 (4.8)	80 (5.5)	90 (6.2)
25-A	3100 (1406)	4500 (2041)	5600 (2540)	6550 (2971)	7400 (3357)	8150 (3697)	8800 (3992)	9400 (4264)	10200 (4627)
21 & 221	4100 (1860)	6000 (2722)	7500 (3402)	8600 (3901)	9600 (4355)	10500 (4763)	11300 (5126)	12000 (5443)	13200 (5988)
847	1000 (454)	1500 (680)	1800 (816)	2100 (953)	2400 (1089)	2600 (1179)	2800 (1270)	3000 (1361)	3300 (1497)
851	2000 (907)	3000 (1361)	3700 (1678)	4300 (1850)	4800 (2177)	—	—	—	—
851-S	3000 (1361)	4000 (1814)	5000 (2268)	6200 (2812)	—	—	—	—	—
551-S	2500 (1134)	3600 (1633)	4500 (2041)	5200 (2359)	5800 (2631)	6500 (2948)	7000 (3175)	7600 (3447)	8800 (3992)

Water Feeders – Make-Up

Series 25-A Make-Up Water Feeder



- For boiler receiver tanks
- Float operated
- Proportional feed action
- Soft seat provides positive seal
- Seal between float chamber and valve chamber is not a positive seal
- Maximum water supply pressure 100 psi (7 kg/cm²)
- Maximum inlet water temperature 120°F (49°C)
- Maximum vessel pressure 35 psi (2.5 kg/cm²)



Series 25-A

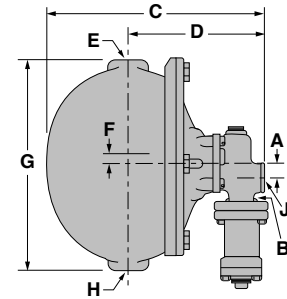

Dimensions, in. (mm)

A	B NPT	C	D	E NPT	F	G	H NPT	J NPT
1 ³ / ₁₆ (21)	3/4	12 ¹ / ₄ (311)	8 ¹ / ₈ (206)	1	1/2 (12.7)	10 ³ / ₈ (264)	1	3/4

Ordering Information

Model Number	Part Number	Description	Weight lbs. (kg)
25-A	126800	Make-up water feeder	37.5 (17)
25-AB	126900	25-A w/float block	41.8 (19)

Capacities

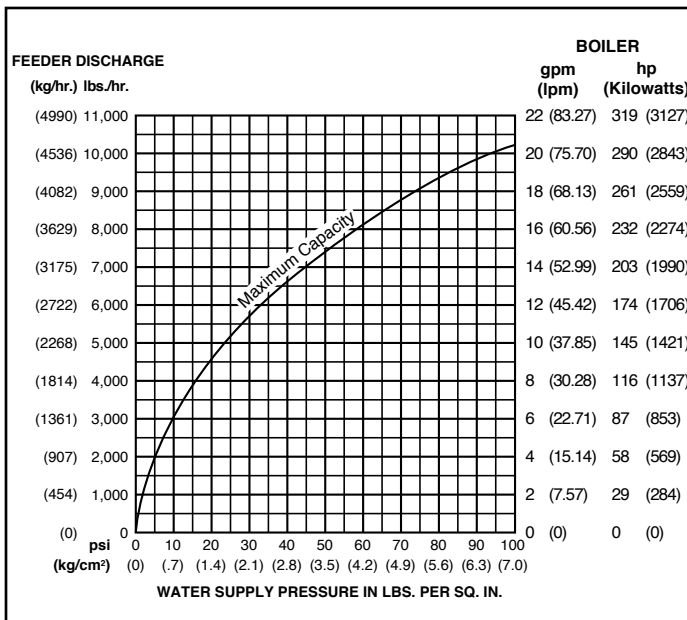

Water Feeders – Make-Up

Series 21 Make-Up Water Feeder

- For boiler receiver tanks
- Direct mounting eliminates need for equalizing connections
- Proportional feed action
- Mounting Flange – six $\frac{7}{16}$ " (11.1mm) bolt holes on a $5\frac{3}{4}$ " (146mm) bolt circle
- Soft seat provides positive seal
- Maximum water supply pressure 150 psi (10.5 kg/cm²)
- Maximum inlet water temperature 120°F (49°C)
- Maximum vessel pressure 35 psi (2.5 kg/cm²)



Series 21

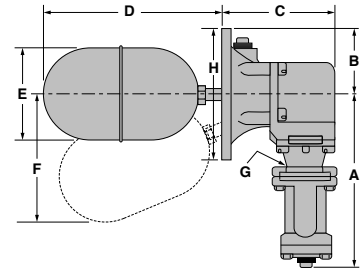

Dimensions, in. (mm)

A	B	C	D	E	F	G NPT	H
8½ (216)	3⅝ (84)	5⅝ (143)	8⅓⅓ (224)	4¾ (121)	6¼ (159)	¾	7⅝ (186)

Series 221 Make-Up Water Feeder

- For boiler receiver tanks
- Direct mounting eliminates need for equalizing connections
- Proportional feed action
- Mounting Flange – six $1\frac{7}{32}$ " (13.5mm) bolt holes on a $8\frac{1}{2}$ " (216mm) bolt circle
- Soft seat provides positive seal
- Maximum water supply pressure 150 psi (10.5 kg/cm²)
- Maximum inlet water temperature 120°F (49°C)
- Maximum vessel pressure 35 psi (2.5 kg/cm²)



Series 221

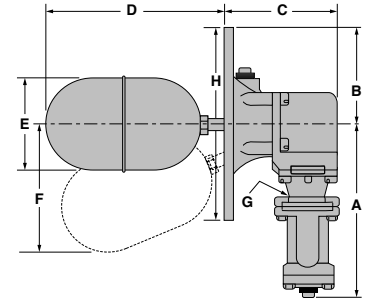

Dimensions, in. (mm)

A	B	C	D	E	F	G NPT	H
8½ (216)	4Ⅰ⅓ (84)	5⅝ (143)	8⅓⅓ (224)	4¾ (121)	6¼ (159)	¾ (20)	9½ (241)

Capacities

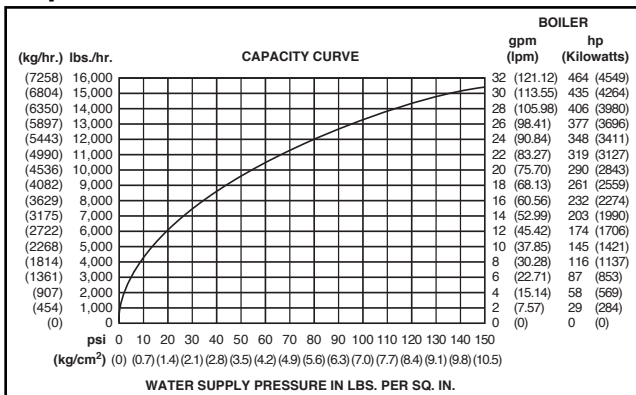

Ordering Information

Model Number	Part Number	Description	Weight lbs. (kg)
21	126400	Make-up water feeder	15.3 (6.9)
221	126600	Make-up water feeder	21.3 (9.7)

Water Feeders – Make-Up

Series 847 Make-Up Water Feeder

- For receiver tanks in commercial or industrial applications
- Mounts directly on the receiver, eliminating need for equalizing connections
- Quick-change replaceable cartridge valve and strainer
- Proportional feed action
- Mounting Flange – six 7/16" (11.1mm) bolt holes on a 5 3/4" (146mm) bolt circle
- Optional features
 - No. 2 switch
 - Alternate valve orientation
- Maximum supply pressure 150 psi (10.5 kg/cm²)
- Maximum inlet water temperature 120°F (49°C)
- Maximum receiver pressure 25 psi (1.8 kg/cm²)

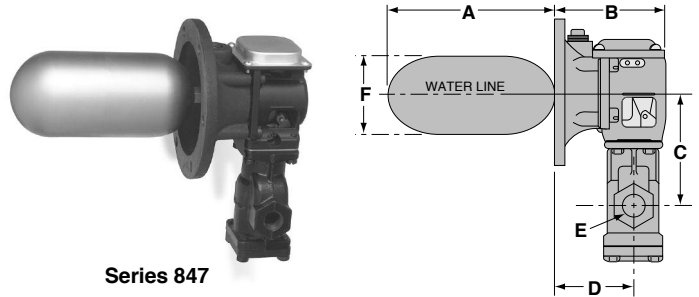

Dimensions, in. (mm)

A	B	C	D	E NPT	F
7 5/16 (186)	4 15/16 (125)	4 5/8 (117)	3 9/16 (90)	1/2	3 7/16 (87)

Ordering Information

Model Number	Part Number	Description	Weight lbs. (kg)
847	134300	Make-up water feeder	11 (5.0)
847-C	134350	847 w/alternate valve orientation	12 (5.4)
847-C-2	134400	847-C w/No. 2 switch	12 (5.4)

Capacities

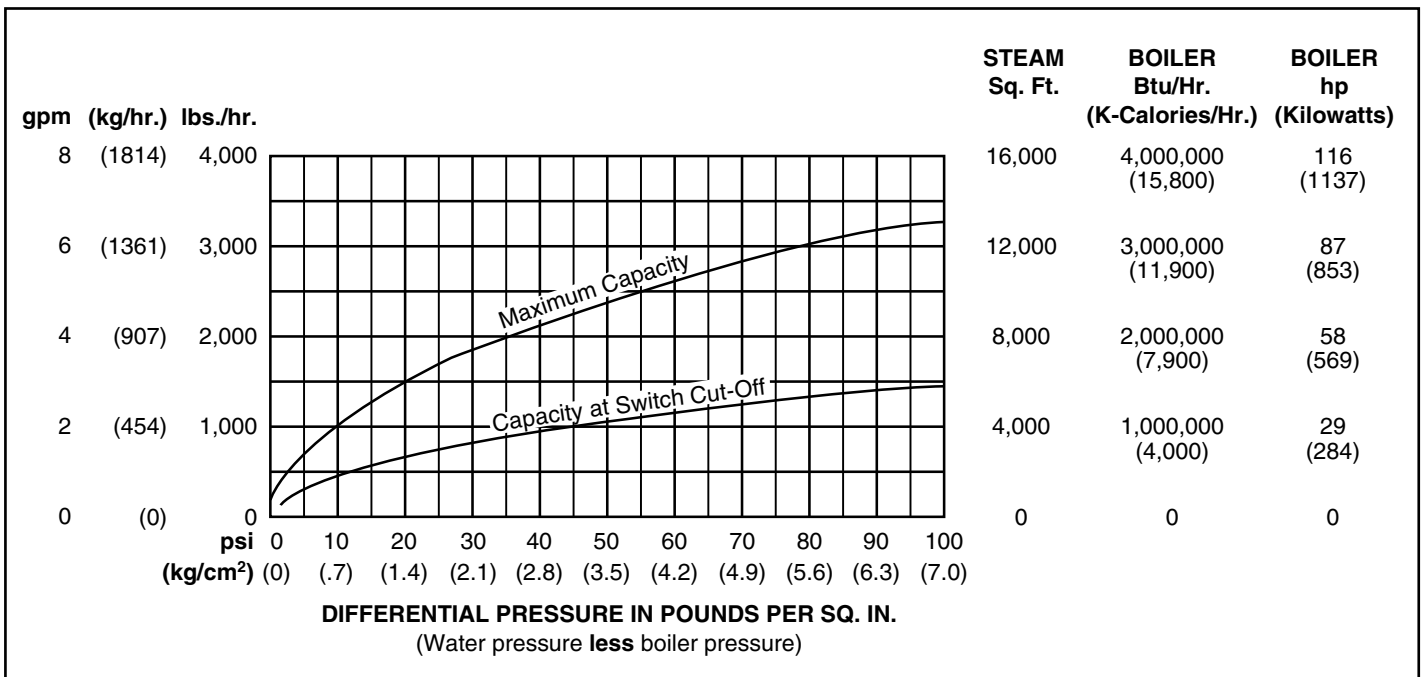

Water Feeders – Make-Up

Series 851 Make-Up Water Feeder

- For receiver tanks in commercial or industrial applications
- Mounts directly on the receiver, eliminating need for equalizing connections
- Quick-change replaceable cartridge valve and strainer
- Proportional feed action
- Mounting Flange – six 7/16" (11.1mm) bolt holes on a 5 3/4" (146mm) bolt circle
- Maximum water supply pressure 150 psi (10.5 kg/cm²)
- Maximum inlet water temperature 120°F (49°C)
- Maximum receiver pressure 35 psi (2.5 kg/cm²)

Model 851-S Make-Up Water Feeder

- Extended float and rod assembly
- Wider operating range
- Maximum water supply pressure 100 psi (7 kg/cm²)
- Maximum inlet water temperature 120°F (49°C)
- Maximum receiver pressure 35 psi (2.5 kg/cm²)

Ordering Information

Model Number	Part Number	Description	Weight lbs. (kg)
851	136700	Make-up water feeder	14 (6.4)
851-S	136800	851 w/extended float & rod assy.	16 (7.3)

Capacities – Model 851

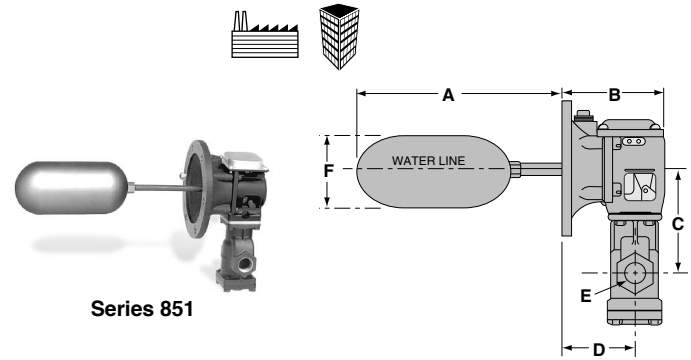
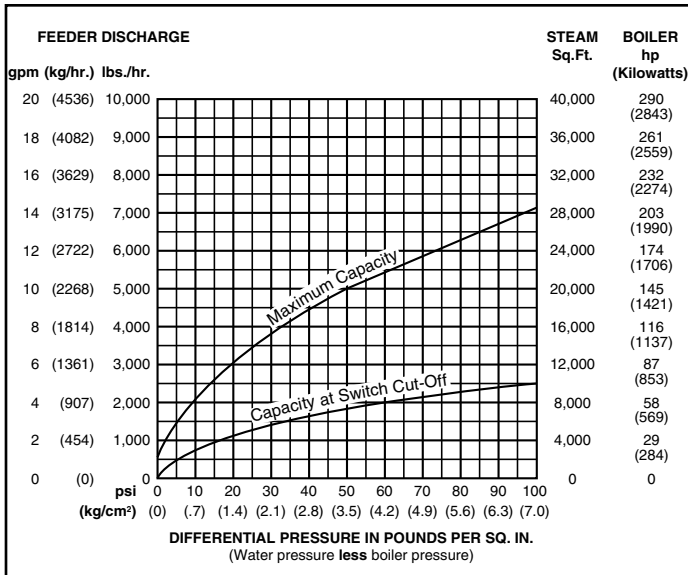

Dimensions, in. (mm)

A	B	C	D	E NPT	F
11 3/4 (298)	4 15/16 (125)	4 5/8 (117)	3 9/16 (90)	3/4	3 7/16 (87)

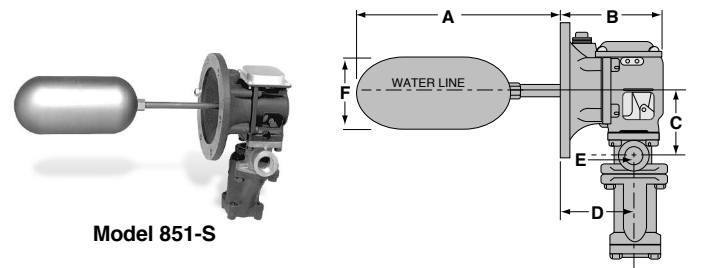

Dimensions, in. (mm)

A	B	C	D	E NPT	F
12 3/4 (324)	4 15/16 (125)	3 3/16 (81)	3 9/16 (90)	3/4	3 7/16 (87)

Capacities – Model 851-S

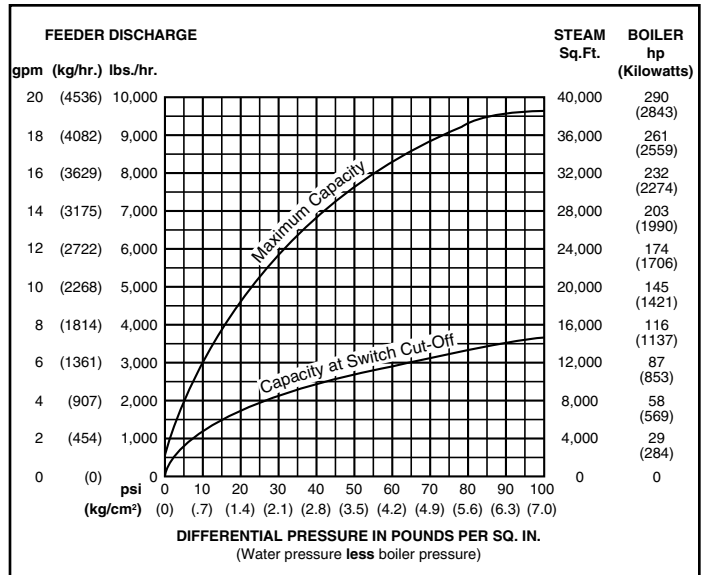

Water Feeders – Make-Up

Series 551-S Make-Up Water Feeder



- For applications where water is added to steam separators, receivers, tanks, or other vessels
- Proportional feed action
- Quick-change replaceable cartridge valve and strainer
- Optional features
 - Float Block
- Maximum water supply pressure 75 psi (5.3 kg/cm²)
- Maximum inlet water temperature 120°F (49°C)
- Maximum vessel pressure 25 psi (1.8 kg/cm²)



551-S

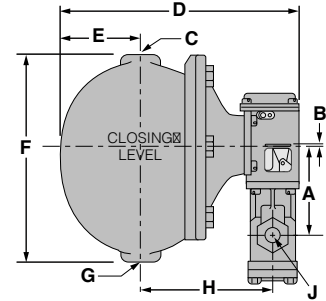

Dimensions, in. (mm)

A	B	C NPT	D	E	F	G NPT	H	J NPT
4 ⁵ / ₈ (117)	1 ¹ / ₈ (3.2)	1	12 ¹ / ₄ (311)	4 ¹ / ₈ (105)	10 ³ / ₈ (264)	1	6 ¹¹ / ₁₆ (170)	3 ³ / ₄

Ordering Information

Model Number	Part Number	Description	Weight lbs. (kg)
551-S	136400	Make-up water feeder	35.8 (16.2)
551-SB	136500	551-S w/float block	35.8 (16.2)

Capacities

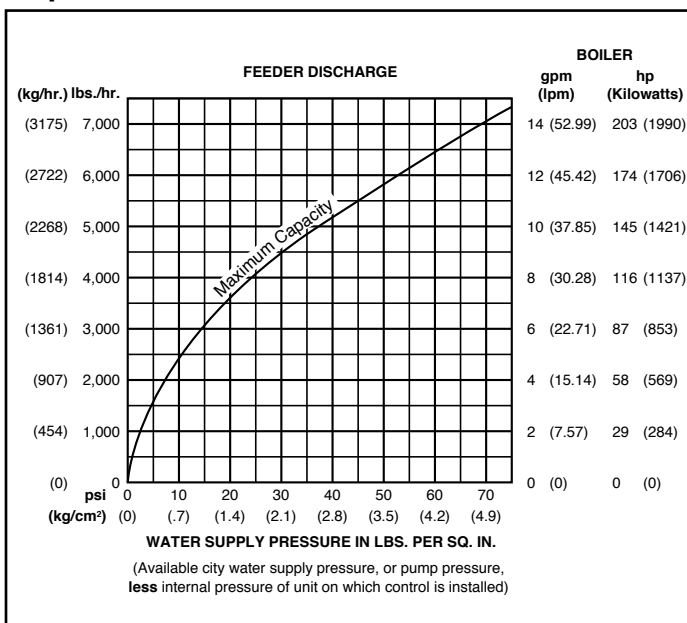

Valves



Series 14-B Ball Type Blow Down Valve

- For McDonnell & Miller Series 47 and 67 boiler control blow down valve replacement
- Full-ported ball action valve
- PTFE seats provide bind free, leak tight ball movement
- Easy open handle keeps hands away from hot water and steam
- Gasket and mounting screws included
- Maximum pressure 30 psi (1.8 kg/cm²)
- See page 121 for blow-down information



Series 14-B

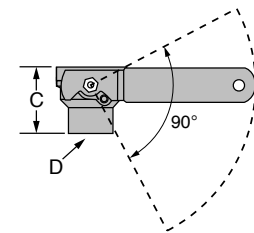
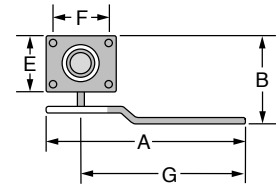

Dimensions, in. (mm)

A	B	C	D NPT	E	F	G
6 ³ / ₄ (171.4)	4 (102)	2 ¹ / ₄ (57)	³ / ₄	2 ¹ / ₂ (64)	2 ¹ / ₂ (64)	5 ³ / ₄ (146)

Ordering Information

Model Number	Part Number	Description	Weight lbs. (kg)
14-B	310447	Blow down valve	1 (.5)

Series TC-4 Test-N-Check® Valves



- For hot water boilers
- Simplifies ASME CSD-1 code mandated testing of low water cut-offs by eliminating the need to drain the system
- Includes one upper and one lower valve for mounting at crosses in equalizing lines
- Restricts water flow when the low water cut-off's blow down valve is open
- Adjustable built-in vacuum breaker in upper valve provides rapid evacuation of water from the float chamber
- 1" NPT
- Maximum temperature 250°F (121°C)
- Maximum pressure 160 psi (11 kg/cm²)



Series TC-4
Upper Valve

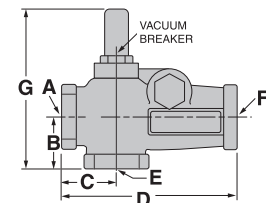

Series TC-4
Lower Valve

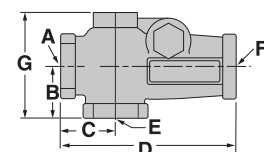

Dimensions, in. (mm)

A NPT	B	C	D
1	1 ¹ / ₂ (38)	1 ¹ / ₂ (38)	5 (125)

E NPT	F NPT	G	
		Upper	Lower
1	1	5 ¹ / ₄ (133)	3 ¹ / ₁₆ (78)

Ordering Information

Model Number	Part Number	Description	Weight lbs. (kg)
TC-4	195000	Test-N-Check Valves, set of 2	5.3 (.4)

Valves



Series 250 Pressure Relief Valves

- For tanks and hydronic heating systems
- Protects against over-pressure
- Minimizes hammering with flash steam
- Low differential pressure – 3 psi (.21 kg/cm²) between opening and closing
- Meets ASME Pressure Vessel and Boiler Code, Section IV
- Sizes and material
 - 3/4" - 1" NPT – bronze body and seat
 - 2" NPT – cast iron body, brass seat
- EPDM rubber diaphragm and seat disc
- Maximum temperature 250°F (121°C)
- Maximum operating pressure range 30 - 125 psig (2.1 - 8.8 kg/cm²)

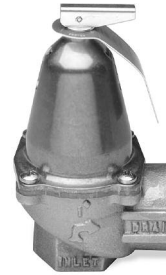

Series 250
3/4" - 1" (20-25mm) NPT

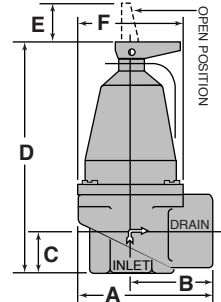

Series 250
2" (50mm) NPT

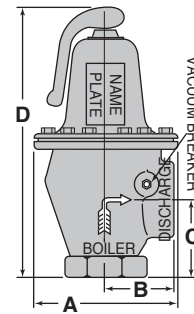

Dimensions, in. (mm)

Size NPT	A	B	C	D	E	F
3/4	2 5/16 (65)	1 1/2 (38)	3/4 (20)	4 9/16 (116)	1 1/32 (26)	2 3/32 (53.2)
1	2 7/8 (73)	1 3/4 (45)	7/8 (22)	4 15/16 (125)	1 1/32 (26)	2 1/4 (57)
2	6 (152)	2 7/8 (73)	3 1/4 (83)	11 (279)	—	—

Series 260 Pressure Relief Valves

- For water tanks and hydronic heating systems
- Protects against over-pressure
- Minimizes hammering with flash steam
- Low differential pressure – 3 psi (.21 kg/cm²) between opening and closing
- Meets ASME Pressure Vessel and Boiler Code, Section IV
- Sealed spring chamber prevents scale or sediment build-up around seal
- 1 1/2" NPT Inlet and 2" NPT Discharge
- Cast iron body, brass seat
- Maximum temperature 250°F (121°C)
- Maximum operating pressure range 30 - 50 psig (2.1 - 3.5 kg/cm²)



Series 260

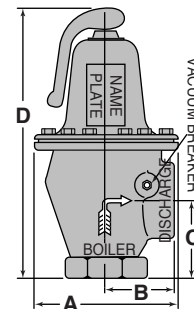

Dimensions, in. (mm)

Size		A	B	C	D
NPT Inlet	NPT Outlet				
1 1/2	2	6 (152)	2 7/8 (73)	3 1/4 (83)	11 (279)

Series 250 Pressure Relief Valves

Performance

Model Number	Opening Pressure psig (kg/cm ²)	ASME Rating BTUH (K-Calories)
250-3/4IN-15	15 (1)	515,000 (2,043)
250-3/4IN-30	30 (2.1)	790,000 (3,134)
250-3/4IN-36	36 (2.5)	900,000 (3,571)
250-3/4IN-40	40 (2.8)	973,000 (3,861)
250-3/4IN-45	45 (3.2)	1,065,000 (4,226)
250-3/4IN-50	50 (3.5)	1,160,000 (4,603)
250-3/4IN-60	60 (4.2)	1,252,000 (4,968)
250-3/4IN-75	75 (5.3)	1,615,000 (6,409)
250-3/4IN-100	100 (7)	2,075,000 (8,234)
250-3/4IN-125	125 (8.8)	2,535,000 (11,059)
250-1IN-15	15 (1)	770,000 (3,056)
250-1IN-30	30 (2.1)	1,170,000 (4,642)
250-1IN-36	36 (2.5)	1,330,000 (5,278)
250-1IN-40	40 (2.8)	1,437,000 (5,702)
250-1IN-45	45 (3.2)	1,575,000 (6,250)
250-1IN-50	50 (3.5)	1,710,000 (6,786)
250-1IN-65	65 (4.6)	2,110,000 (8,373)
250-1IN-75	75 (5.3)	2,385,000 (9,464)
250-1IN-100	100 (7)	3,060,000 (12,142)
250-1IN-125	125 (8.8)	3,735,000 (14,821)
250-2IN-30	30 (2.1)	4,100,000 (16,270)
250-2IN-36	36 (2.5)	4,600,000 (18,254)
250-2IN-40	40 (2.8)	5,000,000 (19,841)
250-2IN-45	45 (3.2)	5,500,000 (21,825)
250-2IN-50	50 (3.5)	5,900,000 (23,412)

Ordering Information

Model Number	Part Number	Description	Weight lbs. (kg)
250-3/4IN-15	181220	Relief Valve 3/4 NPT, 15 psi (1 kg/cm ²)	1.3 (.6)
250-3/4IN-30	181225	Relief Valve 3/4 NPT, 30 psi (2.1 kg/cm ²)	1.3 (.6)
250-3/4IN-36	181325	Relief Valve 3/4 NPT, 36 psi (2.5 kg/cm ²)	1.3 (.6)
250-3/4IN-40	181405	Relief Valve 3/4 NPT, 40 psi (2.8 kg/cm ²)	1.3 (.6)
250-3/4IN-45	181425	Relief Valve 3/4 NPT, 45 psi (3.2 kg/cm ²)	1.3 (.6)
250-3/4IN-50	181525	Relief Valve 3/4 NPT, 50 psi (3.5 kg/cm ²)	1.3 (.6)
250-3/4IN-60	181905	Relief Valve 3/4 NPT, 60 psi (4.2 kg/cm ²)	1.3 (.6)
250-3/4IN-75	181625	Relief Valve 3/4 NPT, 75 psi (5.3 kg/cm ²)	1.3 (.6)
250-3/4IN-100	181725	Relief Valve 3/4 NPT, 100 psi (7 kg/cm ²)	1.3 (.6)
250-3/4IN-125	181825	Relief Valve 3/4 NPT, 125 psi (8.8 kg/cm ²)	1.3 (.6)
250-1IN-15	181920	Relief Valve 1 NPT, 15 psi (1 kg/cm ²)	1.5 (.7)
250-1IN-30	181925	Relief Valve 1 NPT, 30 psi (2.1 kg/cm ²)	1.5 (.7)
250-1IN-36	182025	Relief Valve 1 NPT, 36 psi (2.5 kg/cm ²)	1.5 (.7)
250-1IN-40	182030	Relief Valve 1 NPT, 40 psi (2.8 kg/cm ²)	1.5 (.7)
250-1IN-45	182125	Relief Valve 1 NPT, 45 psi (3.2 kg/cm ²)	1.5 (.7)
250-1IN-50	182225	Relief Valve 1 NPT, 50 psi (3.5 kg/cm ²)	1.5 (.7)
250-1IN-65	182235	Relief Valve 1 NPT, 65 psi (4.6 kg/cm ²)	1.5 (.7)
250-1IN-75	182325	Relief Valve 1 NPT, 75 psi (5.3 kg/cm ²)	1.5 (.7)
250-1IN-100	182425	Relief Valve 1 NPT, 100 psi (7 kg/cm ²)	1.5 (.7)
250-1IN-125	182525	Relief Valve 1 NPT, 125 psi (8.8 kg/cm ²)	1.5 (.7)
250-2IN-30	183025	Relief Valve 2 NPT, 30 psi (2.1 kg/cm ²)	17.3 (7.8)
250-2IN-36	183125	Relief Valve 2 NPT, 36 psi (2.5 kg/cm ²)	17.3 (7.8)
250-2IN-40	183175	Relief Valve 2 NPT, 40 psi (2.8 kg/cm ²)	17.3 (7.8)
250-2IN-45	183225	Relief Valve 2 NPT, 45 psi (3.2 kg/cm ²)	17.3 (7.8)
250-2IN-50	183325	Relief Valve 2 NPT, 50 psi (3.5 kg/cm ²)	17.3 (7.8)

Series 260 Pressure Relief Valves

Performance

Model Number	Opening Pressure psig (kg/cm ²)	ASME Rating BTUH (K-Calories)
260-1 1/2IN-30	30 (2.1)	3,300,000 (13,095)
260-1 1/2IN-36	36 (2.5)	3,800,000 (15,079)
260-1 1/2IN-40	40 (2.8)	4,100,000 (16,270)
260-1 1/2IN-45	45 (3.2)	4,500,000 (17,857)
260-1 1/2IN-50	50 (3.5)	4,900,000 (19,444)

Ordering Information

Model Number	Part Number	Description	Weight lbs. (kg)
260-1 1/2IN-30	182625	Relief Valve 1 1/2 NPT, 30 psi (2.1 kg/cm ²)	17.3 (7.8)
260-1 1/2IN-36	182725	Relief Valve 1 1/2 NPT, 36 psi (2.5 kg/cm ²)	17.3 (7.8)
260-1 1/2IN-40	182730	Relief Valve 1 1/2 NPT, 40 psi (2.8 kg/cm ²)	17.3 (7.8)
260-1 1/2IN-45	182825	Relief Valve 1 1/2 NPT, 45 psi (3.2 kg/cm ²)	17.3 (7.8)
260-1 1/2IN-50	182925	Relief Valve 1 1/2 NPT, 50 psi (3.5 kg/cm ²)	17.3 (7.8)

Remote Sensor Location

The location of the remote sensor is not limited to mounting on top of a tank. Depending on the application, it may be decided to mount the remote sensor in a stillwell or equalizing line. The following diagrams show typical locations for several applications.

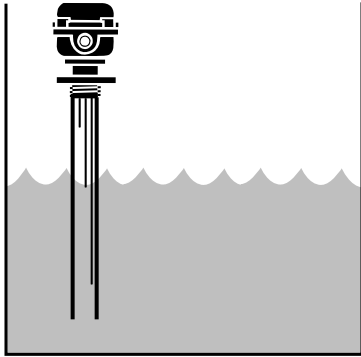

Open tanks or vessels will probably require mounting the remote sensor on a stillwell to dampen the liquids' wave action. Use 3" or 4" perforated plastic drain pipe with a flange to thread connection at the top. The stillwell can rest on the bottom of the tank or be suspended and secured with brackets.

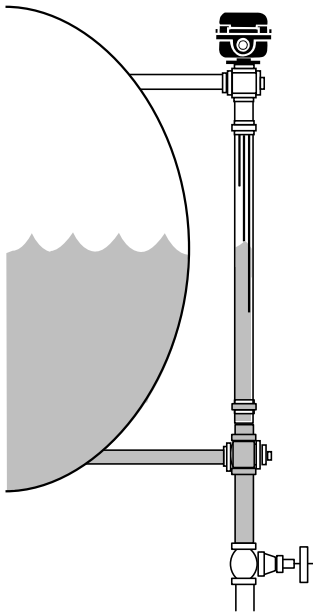

Mounting the remote sensor in an equalizing pipe is an alternative to top mounting. The equalizing pipe should be at least a 2" pipe and have a drain valve at the bottom for flushing.

Probe Installation

All boiler manufacturers designate the preferred (and sometimes secondary) location for installation of the probe on their boiler. They have determined that this location is above the minimum safe water level and provides the 1/4" clearance needed to ensure the probe is not grounded. Always install the probe in these locations, especially on a hot water boiler. If installed in other locations on a hot water boiler, this area could be prone to develop an air pocket.

Installation in piping external to the boiler on hot water systems has pitfalls. If the probe is too long and touches the wall of the pipe, the circuit is completed and the control "thinks" there is water in the system. If the water level drops below the level of the probe in this situation, the burner circuit will never be interrupted and a dry-fire could occur.

The most common problem with installation on hot water systems occurs when installing the probe in copper pipe. The sweat to thread adapters installed could result in the probe not being inserted in the pipe. An air pocket could develop or scale bridging could occur. While an air pocket causes nuisance shutdown of the boiler, scale bridging can result in a dry-fire if the water drops below the level of the probe. Always make sure at least 1/2 the length of the probe is in the run of the pipe to ensure proper operation.

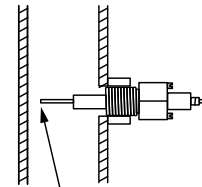

Make sure tip of probe is in pipe with 1/4" clearance from wall of pipe.

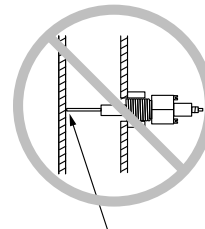

If probe is installed too close to boiler wall, an electrical short could occur.

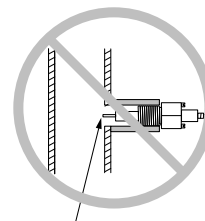

If probe is installed with extensions, an air pocket could develop shutting down the boiler. Debris could develop which can cause an electric short, rendering the low water cut-off ineffective.

Operation and Selection

A conductance-type control, Series 1575 will sense liquids up to 60,000 ohms resistivity. It can be used to activate a low level alarm, high level alarm, pumps to fill/drain a tank or any combination thereof. Typical applications include, but are not limited to, cooling towers, storage tanks, water fountains and condensate receivers.

The control utilizes the conductivity of a liquid to make or break circuits. Some liquids may be more resistive than the control can sense (above 60,000 ohms). The resistive and conductive properties of a liquid depend on several factors, including the amount of soluble material, temperature of the liquid, and placement of the probes. A TDS tester, which can be purchased from a supply house carrying boiler chemicals, is required to accurately measure a liquid's resistivity.

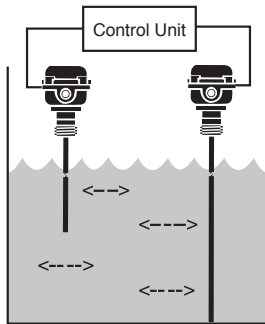

For many applications, water is the liquid being sensed. Raw or tap water usually has naturally occurring salts, chlorides and minerals that make it conductive enough to operate the control. Condensate receiver and cooling tower water are also very conductive due to evaporation. Ultrapure water (RO, deionized, demineralized, etc.) is highly resistive and is not able to conduct the current needed to operate the control.

Refer to the following charts to determine the resistivity of the liquid in an application. If it is above the 60,000 ohm rating, another type of control will be required.

Conductivity Values of Water

Liquid	Resistivity (Ohms/cm)	Conductivity (Micromhos/cm)
Water - Deionized	2,000,000	0.5
Water - Distilled	450,000	2
Water - Condensate	18,000	50
Water - Chlorinated	5,000	200
Water - Hard/Natural	5,000	200
Water - Sewage	5,000	200
Water - Salt	2,200	450

Converting Total Dissolved Solids to Resistivity and Conductivity

Total Dissolved Solids (ppm)	Resistivity (Ohms/cm)	Conductivity (Micromhos/cm)
0.0277	18,000,000	0.056
0.0417	12,000,000	0.084
0.0833	6,000,000	0.167
0.500	1,000,000	1.00
1.25	400,000	2.50
10.0	50,000	20.0
100	5,000	200
1,000	500	2,000
10,000	50	20,000

Series RS – High Pressure Sensors & Probes For Conductance Actuated Controls

Series RS Sensors

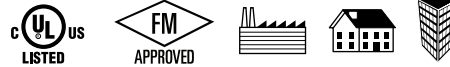

Series-RS-X-BR-1:

- NEMA 4X Enclosure
- For sophisticated multi-level control in tanks, boilers and hydronic systems
- Remote sensors, which thread into the top of the boiler or tank, are available with 1, 2, 3, 4 or 5 probes of varying lengths that can easily be cut to desired set points
- Probe lengths 12 - 72" (2.5 - 183cm) in 12" (2.5cm) increments (purchased separately)
- **Control, remote sensor and probe(s) must be ordered separately. Order Spacer S-4 when 2 or more probes greater than 36" (914mm) will be used**
- No blow down required
- Maximum Temperature 406°F (208°C)
- Maximum Pressure 250 psig (17.6 kg/cm²)



High Pressure Remote Sensor Model RS-1-BR-1

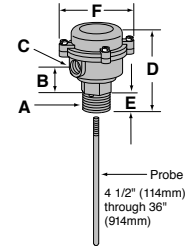

High Pressure Remote Sensor Model RS-2-BR-1 Model RS-3-BR-1

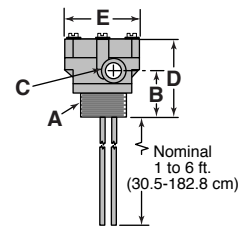

High Pressure Remote Sensors and Probes

Model Number	Part Number	Description	Weight lbs. (kg)
RS-1-BR-1	179524	Remote Sensor; 1 level	1.7 (.8)
RS-2-BR-1	179525	Remote Sensor; 2 levels	3.3 (1.5)
RS-3-BR-1	179526	Remote Sensor; 3 levels	3.3 (1.5)
RS-4-BR-1	179527	Remote Sensor; 4 levels	4.0 (1.8)
RS-5-BR-1	179528	Remote Sensor; 4 levels for non-metallic tanks	4.3 (1.95)

See page 74 for probe rods.



High Pressure Remote Sensor Model RS-4-BR-1 Model RS-5-BR-1

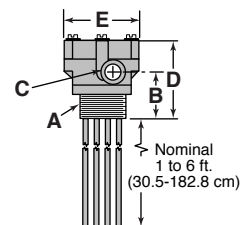

Dimensions, in. (mm)

Remote Sensor	A	B	C
1 Probe	1 NPT	1 ¹ / ₁₆ (43)	1/2 NPT
2 or 3 Probes	2 NPT	2 ¹ / ₃₂ (59.5)	1/2 NPT
4 or 5 Probes	2 ¹ / ₂ NPT	2 ¹⁵ / ₃₂ (63)	1/2 NPT

Remote Sensor	D	E	F
1 Probe	4 ⁹ / ₁₆ (116)	1 ¹ / ₄ (32)	3 ¹ / ₄ (83)
2 or 3 Probes	3 ⁷ / ₈ (98)	4 (102)	-
4 or 5 Probes	4 (102)	4 (102)	-

Sensors – Low Pressure

RS-1-HP

Series-RS High Pressure Remote Sensor:

- NEMA 1 Enclosure
- Maximum Temperature 406°F (208°C)
- Maximum Pressure 250 psig (17.6 kg/cm²)
- For single sensor applications with high-pressure environments. Requires additional probe rod. See page 71.



Remote Sensor
Model RS-1-HP

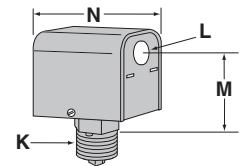

Ordering Information

Model Number	Part Number	Description	Weight lbs. (kg)
RS-1-HP	176199	High pressure remote sensor	0.5 (.23)

Dimensions, in. (mm)

Model	K	L	M	N
RS-1-HP Remote Sensor	3/4 NPT	7/8 (22)	3 (80)	3 3/8 (86)

RS-1-LP

- Maximum Water Temperature: 250°F (121°C) Model RS-1-LP
- Maximum Water Pressure: 160 psi (11.2kg/cm²) Model RS-1-LP
- Maximum Steam Pressure: 15 psig (1.0 kg/cm²)
- Can be installed in horizontal orientation



Remote Sensor
Model RS-1-LP

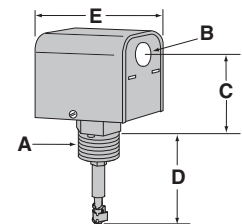

Ordering Information

Model Number	Part Number	Description	Weight lbs. (kg)
RS-1-LP	176203	Remote Sensor	3.0 (1.4)
RS-1-LP-S	176218	Remote Sensor w/short probe	3.0 (1.4)

Dimensions, in. (mm)

A	B	C	D	E
3/4 NPT	7/8 (22)	3 (80)	2 3/4 (70)	3 3/8 (86)

Sensors – High Pressure

Series 750B-C3 Chamber with 3 Probes

Series 750B-C4 Chamber with 4 Probes

Specifications Chamber

- NEMA 4X chamber enclosure
- Maximum steam pressure 250 psig (17.6 kg/cm²)
- Designed for use with a remotely mounted controller to make a complete system for level control in a boiler or other vessel.

Ordering Information

Model Number	Part Number	Description	Weight lbs. (kg)
750B-C3	176316	Cast iron chamber w/3 probes	26 (11.8)
750B-C4	176317	Cast iron chamber w/4 probes	26 (11.8)

Probe Rods

- Stainless steel - Series 316 material
- PTFE coated probe ends provide protection from false signals [available on 24-72" (610 - 1829mm) probes]
- For use with RS sensors

Ordering Information

Model Number	Part Number	Description	Weight lbs. (kg)
G-2-SS	179156	24" (610mm) Ground Probe	1.0 (.5)
G-3-SS	179157	36" (914mm) Ground Probe	1.5 (.7)
G-4-SS	179158	48" (1219mm) Ground Probe	2.0 (.9)
G-5-SS	179159	60" (1524mm) Ground Probe	2.5 (1.1)
G-6-SS	179160	72" (1829mm) Ground Probe	3.0 (1.4)
P-1/3 SS	176208	4 1/2" (114mm) Probe	0.5 (.23)
P-1-SS	179530	12" (305mm) Probe	0.5 (.23)
P-2-SS	179535	24" (610mm) Probe w/PTFE	1.0 (.5)
P-3-SS	179540	36" (914mm) Probe w/PTFE	1.5 (.7)
P-4-SS	179545	48" (1219mm) Probe w/PTFE	2.0 (.9)
P-5-SS	179550	60" (1524mm) Probe w/PTFE	2.5 (1.1)
P-6-SS	179555	72" (1829mm) Probe w/PTFE	3.0 (1.4)



Remote Chamber

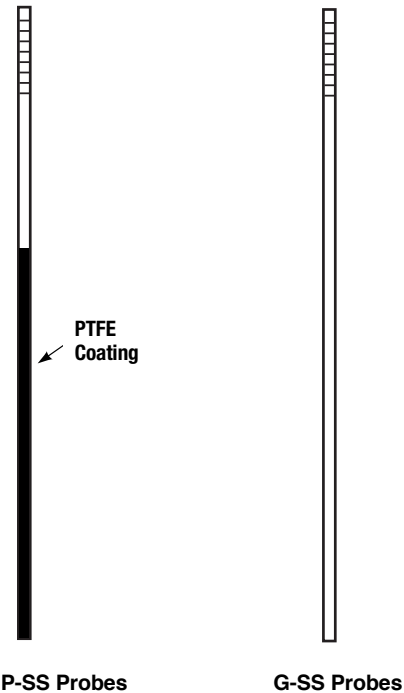
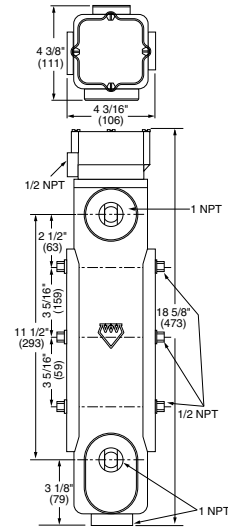

Selecting control according to anticipated use, the sensor should be selected according to the number of probes required. The probe rods are ordered separately according to length needed. The control, sensor and each probe rod must be specified separately, using the appropriate model and part numbers.

PA-800 Series Low Pressure

- Maximum Ambient Temperature: 120°F (49°C)
- Maximum Water Temperature: 250°F (121°C)
- Maximum Water Pressure: 160 psi (11.2 kg/cm²)



Ordering Information

Model Number	Part Number	Control/Sensor Used On	Rod Req.	Weight lbs. (kg)
PA-800	354081	PS-800 Series & RS-1-LP		0.5 (.23)
PA-RB-122	354083	RB-122, RS-1-LP-S & RB-120		0.5 (.23)
PA-800-RX2	354140	PS-800-RX Series		0.5 (.23)
PA-800-U	354141	PS-800-U Series		0.5 (.23)

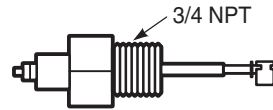

PA-800/SP/PA-RB Series

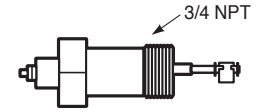

PA-800-U

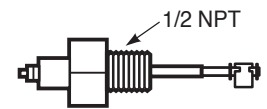

PA-800-RX2

PA-750 Series

Operating Range:

- Maximum System Pressure: 250 psig (17.6 kg/cm²) - High Pressure
- Maximum System Pressure: 15 psig (1.0 kg/cm²) - Low Pressure
- Maximum Temperature at Electrode: 406°F (121°C)

Ordering Information

Model Number	Part Number	Control/Sensor Used On	Rod Req.	Weight lbs. (kg)
PA-750-LP	176318	750P Series	X	0.5 (.23)
PA-750-HP	176319	750B-C & RS-BR Series	X	0.5 (.23)

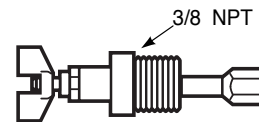

PA-750-LP

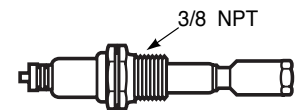

PA-750-HP

Accessories

Ordering Information

Model Number	Part Number	Description	Weight lbs. (kg)
S-4	179529	Spacer use with RS sensors and P&G probes	3.0 (1.4)

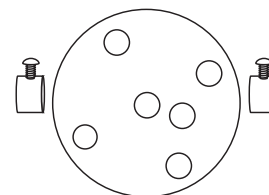

Spacer and Collar

Valve

Series 27-W Liquid Level Controls

- For commercial and industrial liquid level open tank applications
- Materials of construction
 - Brass
 - Monel valve seat, EPDM disc
- Maximum pressure 35 psi (2.5 kg/cm²)
- Maximum supply pressure 100 psi (7 kg/cm²)
- Minimum liquid temperature 40°F (4.4°C)
- Maximum liquid temperature 212°F (100°C)

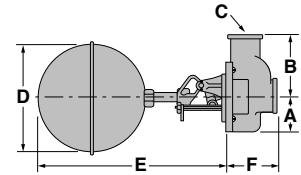

Series 27-W

Dimensions, in. (mm)

A	B	C NPT	D	E	F
1 ⁹ / ₁₆ (40)	2 ⁷ / ₈ (73)	³ / ₄	5 (127)	8 ⁵ / ₈ (219)	2 ⁷ / ₁₆ (62)

Capacities

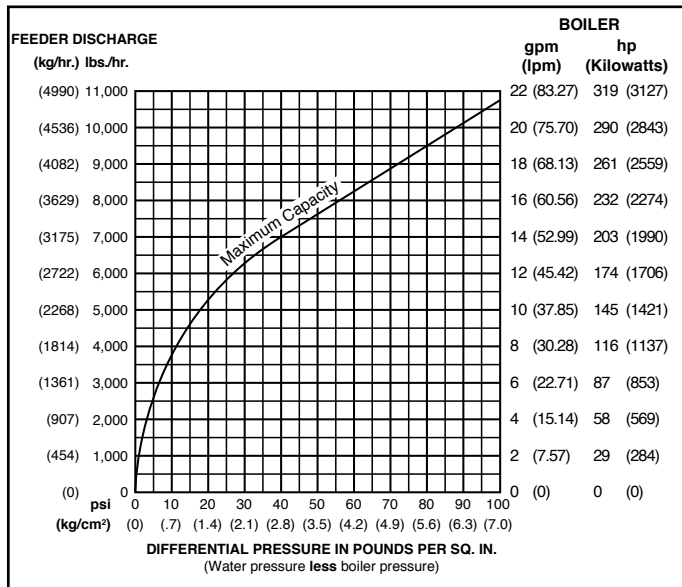

Ordering Information

Model Number	Part Number	Description	Weight lbs. (kg)
27-W	127200	Liquid level control	5 (2.3)

Float Actuated Pneumatic

Series PFC Liquid Level Controls



- For the actuation of pneumatic valves or relays in heating, air conditioning and process systems in hazardous or non-hazardous locations
- Provides an air pressure signal proportional to the liquid level
- Available as Direct Acting or Reverse Acting
- A float operated armature senses the liquid level
- Switch mechanism is completely sealed from the liquid
- Two gauges are provided to display the supply and output pressures
- Alternate air connection tappings are provided for greater flexibility in piping
- Operating range: 1 - 2" (25 - 51mm)
- Air pressure
 - Supply 20 psi (1.4 kg/cm²)
 - Output 3 - 15 psi (.2 - 1 kg/cm²)
- Maximum water temperature 406°F (208°C)
- Maximum pressure 250 psig (17.6 kg/cm²)



Series PFC

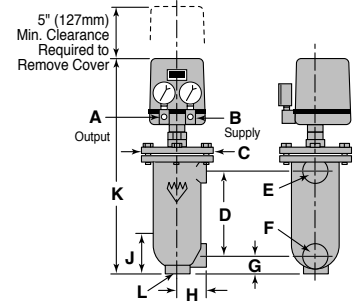

Dimensions, in. (mm)

A NPT	B NPT	C	D	E NPT	F NPT	G	H	J	K	L NPT
1/8	1/8	7 (178)	8 (203)	1	1	1 3/4 (45)	2 5/8 (67)	4 (102)	20 3/4 (527)	1

Water Level Adjustment

Model	Type	Level Adjustment Range in. (mm)
PFC-1-G	Direct Acting	1 - 2 (25 - 51)
PFC-1-GR	Reverse Acting	1 - 2 (25 - 51)

Ordering Information

Model Number	Part Number	Description	Weight lbs. (kg)
PFC-1-G	180800	Direct acting pneumatic liquid level control	38.5 (17.5)
PFC-1-GR	180801	Reverse acting pneumatic liquid level control	38.5 (17.5)

Output Air

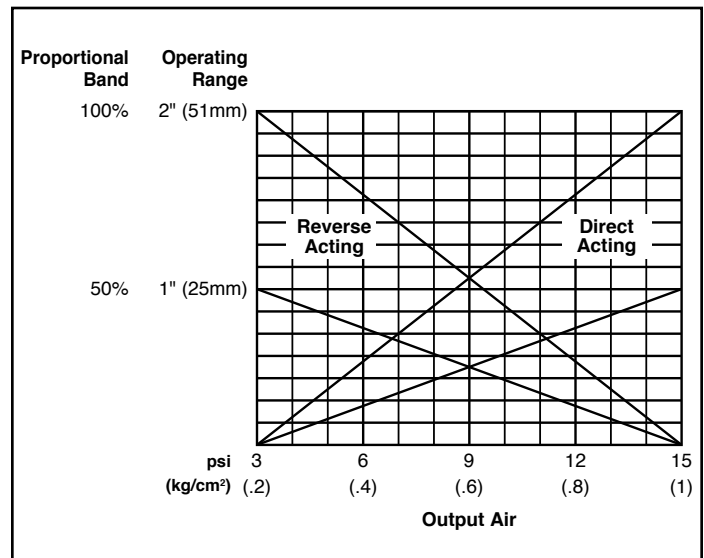

Liquid Flow Switches

The flow of liquids in pipelines plays an important role in industry and commerce. Under most circumstances it is essential to know whether or not there is a flow in a pipeline, and to act upon that knowledge. That is the reason for, and the function of, McDonnell & Miller Flow Switches.

A complete line of Liquid Flow Switches has been developed for a wide range of applications and literally hundreds of uses, including:

- Air Conditioning
- Hot Water Space Heating Systems
- Hot Water Supply Systems
- Pump Systems
- Water Cooled Equipment
- Blending or Additive Systems
- Liquid Transfer Systems
- Fire Sprinkler Systems
- Water Treatment Systems
- Swimming Pool Chlorination
- Industrial Laser Coolant System

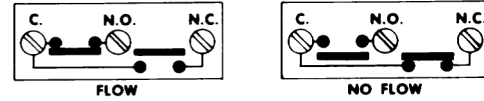

In the tables of flow rates included in this catalog the word “Flow” means that switch will close one circuit and open the other, when flow rate is increased to the rate shown.

The words “No-Flow” mean the switch will reverse position—open first circuit and close the second—when flow rate is decreased to the rate shown.

NOTE: DO NOT USE LIQUID FLOW SWITCHES ON SYSTEMS WITH FLOW GREATER THAN 10 FEET (3M) PER SECOND.

Flow Switches	NEMA Enclosure
All Models	Type 1—General purpose indoor
FS-254, FS1W, FS6W, FS7-4W, FS8W	Type 4X—Watertight, Dust tight and Corrosion resistant
FS7-4E	Type 7—Hazardous Location (Class 1—Group C or D) Type 9—Hazardous Location (Class 2—Group E, F or G)

Models FS74E, FS74SE Flow Switches are Underwriters Laboratories Inc. Listed for use in these hazardous locations:

Class I, Division I, Group C – Atmospheres containing ethylether vapors, ethylene or cyclopropane.

Class I, Division I, Group D – Atmospheres containing gasoline, petroleum, naphtha, benzene, butane, propane, alcohols, acetone, benzol, lacquer solvent vapors or natural gas.

Class II, Division I, Group E – Atmospheres containing dust of aluminum, magnesium or their commercial alloys.

Class II, Division I, Group F – Atmospheres containing carbon black, coal or coke dust.

Class II, Division I, Group G – Atmospheres containing flour, starch or grain dusts.

Note: For other listings contact the factory.

Mounting Methods

With Tee

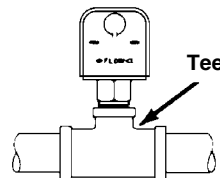

With Welded Half-Coupling

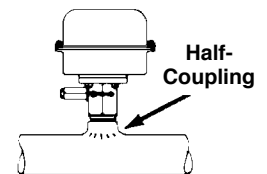

Hex or Face Bushing
FS7-4W

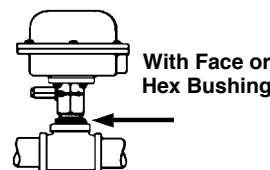

With Body Tapped for Direct Installation
(Series FS1, FS5 and FS6)
FS6

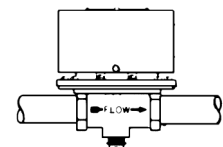

Flow Switch Installation

For best operation, the paddle type flow switches should be installed in a horizontal pipe in the upright position. They should be installed in a threaded pipe tee on 2" or smaller pipe or a welded half coupling when installing on larger welded pipe.

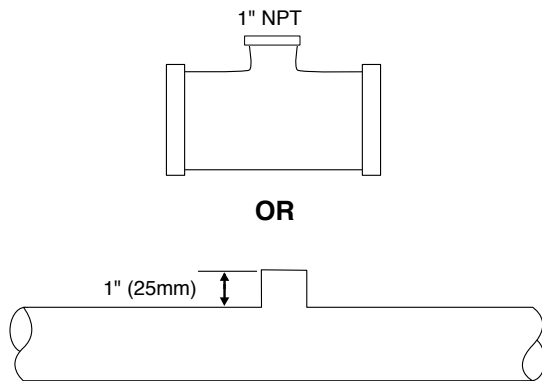

Installation in copper pipe requires special attention. The use of thread to sweat adapters to install the flow switch can cause the paddle arm to be out of the flow of water. It is critical that the paddle and paddle arm be in the run of the pipe for proper operation.

We have found that a paddle type flow switch may not work properly when installed using a thread to sweat adapter. The width of the paddle needs to be reduced in order to fit through the adapter. The additional height locates the paddle arm and a portion of the paddle above the flow of the water (A). This changes the fulcrum point of the mechanism and can result in the paddle hitting the wall of the adapter before it proves. Because the flow switch does not work when first installed, the adjustment screw is turned one way or the other to get it to trip. The combination of trimmed paddle, paddle arm out of flow and attempted adjustment will keep the flow switch from operating properly.

If the flow switch is installed in 2" or smaller copper pipe, the use of a threaded reducing tee and thread to sweat adapters on the main run tee connections would be best (B). Larger pipe may require cutting down the 1" thread to sweat adapter to just below the threads and brazing this piece to a hole in the larger pipe (C). The intention is to maintain the 1" or less distance from the wall of the pipe to the top of the thread adapter. Keeping this distance to less than 1" ensures the paddle arm and paddles are in the flow of water.

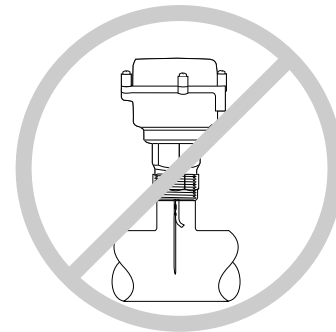

A. Incorrect Installation

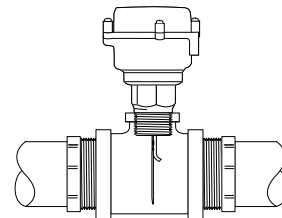

B. Suggested Installation

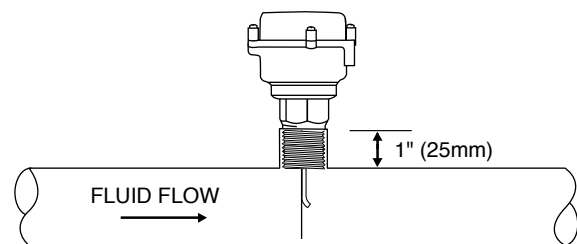

C. Suggested Installation

NOTE: DO NOT USE LIQUID FLOW SWITCHES ON SYSTEMS WITH FLOW GREATER THAN 10 FEET (3M) PER SECOND.

How To Select Liquid Flow Switches

1. What function will the flow switch perform?

McDonnell & Miller Flow Switches are equipped with either one or two SPDT switches. They can make or break an electrical circuit when flow starts or when flow stops, and can be used to:

- Actuate a signal when flow stops
- Start a motor with flow
- Shut off an alarm when flow is adequate
- Stop a motor with no flow

2. Size of pipe

McDonnell & Miller Flow Switches may be used on pipe sizes 1/2" - 36" NPT.

3. How much flow is present?

The flow rate at which the flow switch is to respond should be determined next. McDonnell & Miller Flow Switches are actuated (make or break) with an increase in flow. The term "Flow" represents the actual movement (velocity) of liquid within a pipe sufficient to actuate the switch. The term "No-Flow" represents a decrease in velocity, or total flow stoppage, which will permit the switch to return to its original position.

IMPORTANT: In operation, the switch must be actuated by "Flow" before it can be reversed again by "No-Flow". All McDonnell & Miller Flow Switches can easily be adjusted in the field to require a higher actuating "Flow" or "No-Flow".

4. Maximum liquid pressure in pipe

The maximum pipeline pressure should be considered when selecting a particular model. Different flow switch models can accommodate a range of pipeline pressures up to 1000 psi (70kg/cm²).

5. Maximum temperature

Determine the liquid and ambient atmospheric temperature when selecting the flow switch model. Various McDonnell & Miller Flow Switches can be used at ambient temperatures from 32°F (0°C) and liquid temperatures up to 300°F (149°C). If ambient temperatures are lower than 32°F (0°C) use the FS7-4W.

6. Type of liquid

McDonnell & Miller Flow Switch models have wetted parts of brass, monel or stainless steel. Depending on the particular model they may be used with water, certain light viscous fluids, some oils, various caustic solutions and other fluids.

7. Atmosphere surrounding flow switch

It should be determined if the location will be subject to high humidity, weather conditions or explosive atmospheres. Standard, water tight and hazardous duty flow switch models are available.

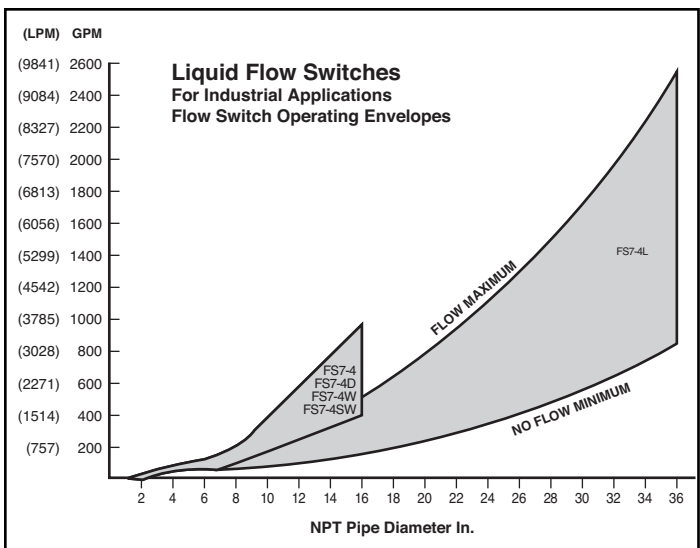
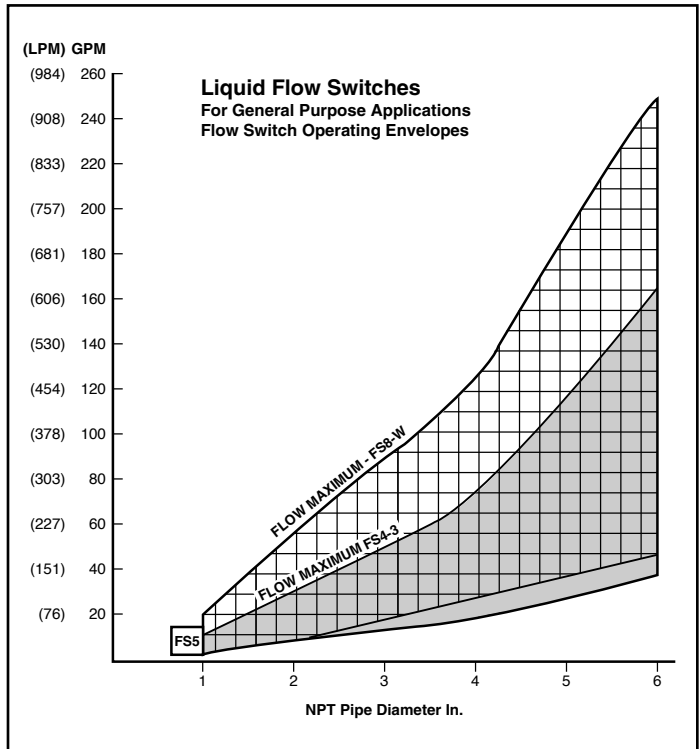

NOTE: DO NOT USE LIQUID FLOW SWITCHES ON SYSTEMS WITH FLOW GREATER THAN 10 FEET (3M) PER SECOND.

8. Incompressible fluids

Fluid flow within a pipe contains both laminar and turbulent flow. The desired placement of any flow switch is in the more predictable laminar flow regions. Turbulent flow is unpredictable, can cause false indications of flow speed and can cause damage to the flow sensing device. An obstruction of flow such as an elbow, fitting or inlet generates a turbulent wave or wake. For that reason placement is recommend at least 5 pipe diameters downstream for liquid flow switches.

In any flow problem, the flow rate in either feet per second (fps) or gallons per minute (gpm) must be established. For your convenience, we have provided the formulas for determining flow in your application. Use the table (below right) to quickly determine the inside area of standard pipes. For nonstandard pipe schedules, determine the inside area by finding the inside diameter and applying the formula to the right.

Position of the Flow Switch

Installing the flow switch in a horizontal run of pipe is recommended. However because of space limitations, the only available installation may be in a vertical section of pipe. The Series FS4-3, FS8-W and FS5 may be used in this situation as they will generally operate satisfactorily when installed in a vertical pipe with either upward or downward flow (upward flow is preferable) **PROVIDED THERE IS NO UNUSUAL AMOUNT OF DIRT OR SEDIMENT IN THE WATER.**

Flow rates required to actuate the Series FS4-3, FS8W and FS5 are not available for vertical pipe installation. A "factory adjusted" flow switch normally does not require any field adjustment for upward or downward flow. But to make sure, it is advisable to hold flow switch in position to be installed and check for "no flow" switch operation by hand operation of the paddle.

The Series FS7-4, FS6, and FS1 must be mounted on upperside of horizontal pipe. These units will not operate properly on a vertical pipe.

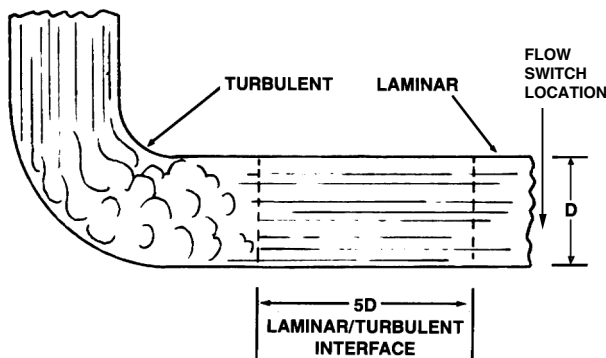

Formulas

Area = D²π/4
D = Inside Diameter
π = 3.14

Formula for large pipe, higher velocities

$$1. \text{ Velocity in ft. per sec. (FPS)} = \frac{\text{GPM} \times 0.321}{\text{Pipe Area in sq. in.}}$$

Example: With a flow of 1200 GPM through an 8" pipe, determine velocity.

$$\text{Velocity} = \frac{1200 \times 0.321}{50.0} \text{ or } 7.7 \text{ ft. per sec.}$$

$$2. \text{ GPM} = \frac{\text{Velocity in ft. per sec.} \times \text{Pipe Area sq. in.}}{0.321}$$

Example: With a flow of 6.5 ft. per sec. through a 10" pipe, determine GPM.

$$\text{GPM} = \frac{6.5 \times 78.9}{0.321} \text{ or } 1600 \text{ GPM}$$

3. LPM = Liters per Minute

$$\text{Velocity in meters per sec. (MPS)} = \frac{\text{LPM} \times .163}{\text{Pipe Area in cm}^2}$$

$$\text{LPM} = \frac{\text{Velocity in meters per sec.} \times \text{Pipe Area in cm}^2}{.163}$$

$$\text{GPM} = \text{LPM} \times .264 \quad \text{LPM} = \frac{\text{GPM}}{.264}$$

Nominal Standard Pipe Size in.	Pipe Schedule No.	Inside Area Sq. in. (cm ²) "A"
1/2	40	.304 (1.96)
3/4	40	.533 (3.44)
1	40	.864 (5.57)
1 1/4	40	1.496 (9.65)
1 1/2	40	2.036 (13.14)
2	40	3.36 (21.68)
2 1/2	40	4.79 (30.90)
3	40	7.39 (47.68)
3 1/2	40	9.89 (63.81)
4	40	12.73 (82.13)
5	40	20.01 (129)
6	40	28.89 (186)
8	40	50.0 (322)
10	40	78.9 (509)
12	30	113.1 (730)
14	30	137.9 (890)
16	30	182.6 (1181)

Liquid Flow Switch Specification Chart

General Purpose Applications															
Model Number	Use on NPT Pipe Sizes	Connection		Wetted Parts						Maximum Pressure		Fluid Temperature °F (°C)		Minimum Ambient Temp. °F (°C)	Switch Enclosure
				psi	kg/cm ²	Min.	Max.								
	in.	NPT	BSPT	Brass	Stainless Steel	Monel	Buna N	Viton	Solder						
FS4-3	1-6	•		•	•	•			•	160	11.3	32 (0)	300 (149)	32 (0)	General Purpose
FS251	1-6	•		•	•	•	2		•	160	11.3	32 (0)	300 (149)	32 (0)	General Purpose
FS4-3D ¹	1-6	•		•	•	•			•	160	11.3	32 (0)	300 (149)	32 (0)	General Purpose
FS4-3J	1-6		•	•	•	•			•	160	11.3	32 (0)	300 (149)	32 (0)	General Purpose
FS4-3RPT	1-6	•		•	•	•			•	160	11.3	32 (0)	300 (149)	32 (0)	General Purpose
FS4-3S	1-6	•			•	•			•	160	11.3	32 (0)	300 (149)	32 (0)	General Purpose
FS5-3/4	3/4	•		•			3			150	10.5	32 (0)	250 (121)	32 (0)	General Purpose
FS5-1	1	•		•			3			150	10.5	32 (0)	250 (121)	32 (0)	General Purpose
FS5-D-3/4 ¹	3/4	•		•			3			150	10.5	32 (0)	250 (121)	32 (0)	General Purpose
FS5-D-1 ¹	1	•		•			3			150	10.5	32 (0)	250 (121)	32 (0)	General Purpose
FS5-J-1	1		•	•			3			150	10.5	32 (0)	250 (121)	32 (0)	General Purpose
FS5-DJ-3/4 ¹	3/4		•	•			3			150	10.5	32 (0)	250 (121)	32 (0)	General Purpose
FS5-S-1	1	•			•		•			150	10.5	32 (0)	225 (107)	32 (0)	General Purpose
FS5-DS-1 ¹	1	•			•		•			150	10.5	32 (0)	225 (107)	32 (0)	General Purpose
FS254	1-6	•		•	•	•	2		•	160	11.3	32 (0)	225 (107)	32 (0)	NEMA 4-X
FS8-W	1-6	•		•	•	•			•	160	11.3	32 (0)	225 (107)	32 (0)	NEMA 4-X
FS8-WJ	1-6		•	•	•	•			•	160	11.3	32 (0)	225 (107)	32 (0)	NEMA 4-X
High Sensitivity Applications															
FS6-3/4	3/4	•		•				•		100	7	32 (0)	225 (107)	32 (0)	General Purpose
FS6-1	1	•		•				•		100	7	32 (0)	225 (107)	32 (0)	General Purpose
FS6-J-3/4	3/4		•	•				•		100	7	32 (0)	225 (107)	32 (0)	General Purpose
FS6-J-1	1		•	•				•		100	7	32 (0)	225 (107)	32 (0)	General Purpose
FS6-W-3/4	3/4	•		•				•		100	7	32 (0)	225 (107)	32 (0)	NEMA 4-X
FS6-W-1	1	•		•				•		100	7	32 (0)	225 (107)	32 (0)	NEMA 4-X
FS6-WJ-3/4	3/4		•	•				•		100	7	32 (0)	225 (107)	32 (0)	NEMA 4-X
FS6-WJ-1	1		•	•				•		100	7	32 (0)	225 (107)	32 (0)	NEMA 4-X
FS1	1/2	•		•	•			•		100	7	32 (0)	225 (107)	32 (0)	General Purpose
FS1-J	1/2		•	•	•			•		100	7	32 (0)	225 (107)	32 (0)	General Purpose
FS1-W	1/2	•		•	•			•		100	7	32 (0)	225 (107)	32 (0)	NEMA 4-X

¹ "D" Denotes 2 SPDT Switches

² EPDM O-ring

³ Ethylene-Propylene Elastomer

⁴ Brazed

NEMA 4X flow switches are water tight, dust tight and corrosion resistant

NEMA7, 9 flow switches are rated for hazardous duty

NOTE: DO NOT USE LIQUID FLOW SWITCHES ON SYSTEMS WITH FLOW GREATER THAN 10 FEET (3M) PER SECOND.

Liquid Flow Switch Specification Chart (continued)

Industrial/Heavy Duty Applications														
Model Number	Use on NPT Pipe Sizes in.	Connection		Wetted Parts					Maximum Pressure		Fluid Temperature °F (°C)		Minimum Ambient Temp. °F (°C)	Switch Enclosure
		NPT	BSPT	Brass	Stainless Steel	Bronze	PTFE	Solder	psi	kg/cm ²	Min.	Max.		
	FS7-4	1 1/4 - 16	•		•	•	•	•	4	300	21	32 (0)	300 (149)	32 (0)
FS7-4D ¹	1 1/4 - 16	•		•	•	•	•	4	300	21	32 (0)	300 (149)	32 (0)	General Purpose
FS7-4E	1 1/4 - 16	•		•	•	•	•	4	300	21	32 (0)	300 (149)	32 (0)	NEMA 7, 9
FS7-4EJ	1 1/4 - 16		•	•	•	•	•	4	300	21	32 (0)	300 (149)	32 (0)	NEMA 7, 9
FS7-4EL	8 - 32	•		•	•	•	•	4	300	21	32 (0)	300 (149)	32 (0)	NEMA 7, 9
FS7-4ELJ	8 - 32		•	•	•	•	•	4	300	21	32 (0)	300 (149)	32 (0)	NEMA 7, 9
FS7-4J	1 1/4 - 16		•	•	•	•	•	4	300	21	32 (0)	300 (149)	32 (0)	General Purpose
FS7-4DJ ¹	1 1/4 - 16		•	•	•	•	•	4	300	21	32 (0)	300 (149)	32 (0)	General Purpose
FS7-4L	8 - 32	•		•	•	•	•	4	300	21	32 (0)	300 (149)	32 (0)	General Purpose
FS7-4LJ	8 - 32		•	•	•	•	•	4	300	21	32 (0)	300 (149)	32 (0)	General Purpose
FS7-4S	1 1/4 - 16	•			•		•	4	1000	70	32 (0)	300 (149)	32 (0)	General Purpose
FS7-4DS ¹	1 1/4 - 16	•			•		•	4	1000	70	32 (0)	300 (149)	32 (0)	General Purpose
FS7-4SE	1 1/4 - 16	•			•		•	4	1000	70	32 (0)	300 (149)	32 (0)	NEMA 7, 9
FS7-4SEJ	1 1/4 - 16		•		•		•	4	1000	70	32 (0)	300 (149)	32 (0)	NEMA 7, 9
FS7-4SJ	1 1/4 - 16		•		•		•	4	1000	70	32 (0)	300 (149)	32 (0)	General Purpose
FS7-4SDJ	1 1/4 - 16		•		•		•	4	1000	70	32 (0)	300 (149)	32 (0)	General Purpose
FS7-4SW	1 1/4 - 16	•			•		•	4	1000	70	-65 (-54)	300 (149)	-65 (-54)	NEMA 4-X
FS7-4SWJ	1 1/4 - 16		•		•		•	4	1000	70	-65 (-54)	300 (149)	-65 (-54)	NEMA 4-X
FS7-4W	1 1/4 - 16	•		•	•	•	•	4	300	21	-65 (-54)	300 (149)	-65 (-54)	NEMA 4-X
FS7-4WJ	1 1/4 - 16		•	•	•	•	•	4	300	21	-65 (-54)	300 (149)	-65 (-54)	NEMA 4-X
FS7-4WL	8 - 32	•		•	•	•	•	4	300	21	-65 (-54)	300 (149)	-65 (-54)	NEMA 4-X
FS7-4WLJ	8 - 32		•	•	•	•	•	4	300	21	-65 (-54)	300 (149)	-65 (-54)	NEMA 4-X

1 "D" Denotes 2 SPDT Switches

2 EPDM O-ring

3 Ethylene-Propylene Elastomer

4 Brazed

NEMA 4X flow switches are water tight, dust tight and corrosion resistant

NEMA 7, 9 flow switches are rated for hazardous duty

NOTE: DO NOT USE LIQUID FLOW SWITCHES ON SYSTEMS WITH FLOW GREATER THAN 10 FEET (3M) PER SECOND.

Flow Velocities

Gallons Per Minute (GPM)

Velocity FPS	Pipe Size (NPT)											
	1/2"	3/4"	1"	1 1/4"	1 1/2"	2"	2 1/2"	3"	3 1/2"	4"	5"	6"
	GPM											
.2	.19	.33	.54	.94	1.27	2.1	3.0	4.8	6.2	7.9	12.5	18
.4	.38	.66	1.08	1.88	2.54	4.2	6.0	9.6	12.4	15.8	25.0	36
.6	.57	.99	1.62	2.92	3.81	6.2	8.9	13.4	18.6	23.7	37.5	54
.8	.76	1.32	2.16	3.76	5.08	8.3	11.9	19.2	24.8	31.6	50.0	72
1.0	.95	1.66	2.70	4.70	6.30	10.5	14.9	23.0	30.8	39.7	65.4	90
1.5	1.42	2.50	4.05	7.10	9.48	15.8	22.4	34.5	46.2	59.6	98.1	135
2.0	1.89	3.32	5.40	9.40	12.6	21.0	29.8	46.0	61.6	79.4	131	180
2.5	2.37	4.16	6.75	11.8	15.8	26.3	37.3	57.5	77.0	99.3	164	225
3.0	2.84	4.94	8.10	14.1	19.0	31.5	44.7	69.0	92.4	119	196	270
3.5	3.31	5.82	9.45	16.5	22.1	36.8	52.2	80.5	108	139	229	315
4.0	3.78	6.65	10.8	18.8	25.3	42.0	59.6	92.0	123	159	262	360
4.5	4.26	7.48	12.2	21.2	28.4	47.3	67.1	104	139	179	294	405
5.0	4.74	8.32	13.5	23.5	31.6	52.5	74.5	115	154	199	327	450
6.0	5.68	9.99	16.2	28.2	37.9	63.0	89.4	138	185	238	392	540
7.0	6.62	11.61	18.9	32.9	44.2	73.5	104	161	216	278	458	630
8.0	7.56	13.32	21.6	37.6	50.5	84.0	119	184	246	318	523	720
9.0	8.52	15.02	24.3	42.3	56.8	94.5	134	207	277	357	589	810
10.0	9.48	16.62	27.0	47.0	63.0	105	149	230	308	397	654	900

Liters Per Minute (LPM)

Velocity MPS	Pipe Size (NPT)											
	1/2"	3/4"	1"	1 1/4"	1 1/2"	2"	2 1/2"	3"	3 1/2"	4"	5"	6"
	LPM											
.06	.72	1.25	2.04	3.56	4.81	7.95	11.4	18.2	23.5	29.9	47.3	68.1
.12	1.44	2.5	4.09	7.12	9.61	15.9	22.7	36.3	46.9	60	94.6	136.2
.18	2.16	3.75	6.13	11.1	14.4	23.5	33.7	50.7	70.4	89.7	141.6	204.4
.24	2.88	5	8.18	14.2	19.2	31.4	45	72	93.9	119.6	189.2	272.5
.30	3.6	6.3	10.2	17.8	23.9	39.7	56.4	87	116.6	150.3	247.5	340.7
.46	5.4	9.5	15.3	26.9	35.9	59.8	84.8	130.6	174.9	225.6	371.3	511
.61	7.2	12.6	20.5	35.4	47.6	79.5	112.8	174.1	233.2	300.5	495.8	681.3
.76	9	15.8	25.6	44.7	59.8	99.6	141.2	217.6	291.5	375.9	620.8	851.6
.91	10.8	18.7	30.7	53.4	71.9	119.2	169.2	261.2	349.7	450.4	741.9	1021.9
1.07	12.6	22	35.8	62.5	83.7	139.3	197.6	304.7	408.8	526.1	866.8	1192.3
1.22	14.3	25.2	40.9	71.2	95.8	159	225.6	348.2	465.6	601.8	991.7	1362.6
1.37	16.1	28.3	46.2	81.2	107.5	179	254	393.6	526.2	677.5	1112.8	1532.9
1.52	17.9	31.5	51.1	89	119.6	198.7	282	435.3	582.9	752.2	1237.7	1703.3
1.83	21.5	37.8	61.3	106.7	143.5	238.5	338.4	522.3	700.2	900.8	1483.7	2043.9
2.13	25.1	43.9	71.5	124.5	167.3	278.2	393.6	609.4	817.6	1052.2	1733.5	2384.6
2.44	28.6	50.4	81.8	144.3	191.1	317.9	450.4	696.4	931.1	1203.6	1979.6	2725.2
2.74	32.3	56.9	92	160.1	215	357.7	507.2	783.5	1048.5	1351.3	2229.4	3065.3
3.05	35.9	62.9	102.2	177.9	238.5	397.4	564	870.6	1165.8	1502.7	2475.4	3406.5

Pressure Drop

PSI

Pipe Size NPT (in.)	Series	Flow Rate (GPM)															
		.2	.5	1.0	2.0	4.0	8.0	10.0	15.0	20.0	25.0	30.0	50.0	75.0	100.0	150.0	200.0
1/2	FS1	.26	.32	.47	.72	2.74	9.74	14.4									
3/4 & 1	FS6	.01	.02	.03	.04	.36	1.44	2.16	4.86	7.94	12.3	18	50				
3/4	FS5 3/4"				1.75	2.25	2.80	3.10	8.05	6.3							
1	FS5 1"				1.75	2.25	2.80	3.10									
1	FS4-3					.15	.32	.54	1.26	2.20							
1	FS8-W				.01	.05	.20	.33	.74	1.30							
1 1/4	FS7-4					.03	.08	.17	.39	.72							
2	FS7-4						.02	.02	.04	.09	.13	.19	.51	.90			
3	FS4-3									.01	.01	.02	.05	.10	.18	.40	.79
3	FS8-W									.01	.01	.02	.06	.10	.13	.17	.19
4	FS7-4												.01	.02	.03	.05	.06
6	FS7-4													.01	.01	.02	.02

kPa

Pipe Size NPT (in.)	Series	Flow Rate (LPM)															
		.76	1.89	3.79	7.57	15.1	30.3	37.9	56.8	75.7	94.6	113.6	189.3	283.9	378.5	567.8	757
1/2	FS1	1.79	2.21	3.24	4.96	18.89	67.15	99.28									
3/4 & 1	FS6	0.07	0.14	0.21	0.28	2.48	9.93	14.89	33.51	54.74	84.81	124.11	344.74				
3/4	FS5 3/4"				12.07	15.51	19.31	21.37	55.50	43.44							
1	FS5 1"				12.07	15.51	19.31	21.37									
1	FS4-3					1.03	2.21	3.72	8.69	15.17							
1	FS8-W				0.07	0.34	1.38	2.28	5.10	8.96							
1 1/4	FS7-4					0.21	0.55	1.17	2.69	4.96							
2	FS7-4						0.14	0.14	0.28	0.62	0.90	1.31	3.52	6.21			
3	FS4-3									0.07	0.07	0.14	0.34	0.69	1.24	2.76	5.45
3	FS8-W									0.07	0.07	0.14	0.41	0.69	0.90	1.17	1.31
4	FS7-4												0.07	0.14	0.21	0.34	0.41
6	FS7-4													0.07	0.07	0.14	0.14

NOTE: DO NOT USE LIQUID FLOW SWITCHES ON SYSTEMS WITH FLOW GREATER THAN 10 FEET (3M) PER SECOND.

Flow Switches – Liquid

Series FS4-3 General Purpose Liquid Flow Switches

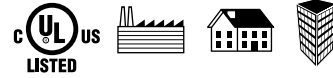

- Universal design serves the widest variety of applications
- For starting or stopping electrically operated equipment such as signal lights, alarms, motors, automatic burners, metering devices and others
- Replacement for common flow switches from Johnson/Penn, Potter/Taco, Watts, Hydrolevel and other manufacturers
- 1" NPT
- Two electrical knock-outs allows connection from either end
- Sensitivity adjusting screw makes flow adjustment easy
- Single pole, double throw snap switch
- Hardened stainless steel bearings minimize friction
- Sealed Monel bellows
- Four stainless steel paddles included - 1", 2", 3" & 6" (25, 50, 80, & 150mm)
- Optional features
 - Two SPDT switches to make or break two separate circuits
 - Materials of construction suitable for corrosive liquids
 - BSPT threads
- Minimum temperature (fluid or ambient) 32°F (0°C)
- Maximum temperature 300°F (149°C)
- Maximum pressure 160 psi (11.3 kg/cm²)



Series FS4-3

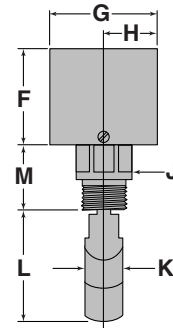
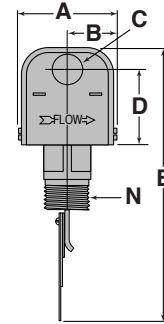

Electrical Ratings

Voltage	Motor Switch Rating (Amperes)		Pilot Duty
	Full Load	Locked Rotor	
120 VAC	7.4	44.4	125 VA at 120 or 240 VAC 50 or 60 cycles
240 VAC	3.7	22.2	

Dimensions, in. (mm)

A	B	C	D	E	F	G
3 (76)	1½ (38)	7⁄8 (22)	2⁷⁄₃₂ (56)	8⁷⁄₁₆ (211)	2¹⁵⁄₁₆ (75)	3³⁄₈ (86)

H	J	K	L	M	N NPT
1¹¹⁄₁₆ (43)	1⁷⁄₁₆ (37)	1½ (29)	3⁷⁄₁₆ (87)	2¹⁄₁₆ (52)	1

Flow Switches – Liquid

Series FS4-3 (continued) General Purpose Liquid Flow Switches

Flow Rates

Pipe Size NPT in.	Settings	Mode of Operation		Max. Flow Rate gpm (lpm) w/o Paddle Damage
		Flow gpm (lpm)	No Flow gpm (lpm)	
1	Factory or Minimum	6 (22.7)	3.6 (13.6)	27 (102.2)
	Maximum	10.2 (38.6)	9.2 (34.8)	
1¼	Factory or Minimum	9.8 (37.1)	5.6 (21.2)	47 (177.9)
	Maximum	16.8 (63.6)	15 (56.8)	
1½	Factory or Minimum	12.7 (48.1)	7 (26.5)	63 (238.5)
	Maximum	23 (87.1)	19.5 (73.8)	
2	Factory or Minimum	18.8 (71.2)	9.4 (35.6)	105 (397.4)
	Maximum	32.8 (124.1)	24 (90.8)	
2½	Factory or Minimum	24.3 (92)	11.6 (43.9)	149 (564)
	Maximum	42.4 (160.5)	37.5 (141.9)	
3	Factory or Minimum	30 (113.6)	12 (45.4)	230 (870.6)
	Maximum	52.1 (197.2)	46.1 (174.5)	
4	Factory or Minimum	39.7 (150.3)	19.8 (74.9)	397 (1502.7)
	Maximum	73.5 (278.2)	64.2 (242)	
5	Factory or Minimum	58.7 (222.2)	29.3 (110.9)	654 (2415.4)
	Maximum	115 (435.3)	92 (348.2)	
6	Factory or Minimum	79.2 (300)	39.6 (150)	900 (3406.5)
	Maximum	166 (628.3)	123 (465.6)	

Values are ± 10%

NOTE: DO NOT USE LIQUID FLOW SWITCHES ON SYSTEMS WITH FLOW GREATER THAN 10 FEET (3M) PER SECOND.

Ordering Information

Model Number	Part Number	Description	Weight lbs. (kg)
FS4-3	114400	General purpose flow switch	1.9 (0.9)
FS4-3J	114610	FS4-3 w/BSPT connections	1.9 (0.9)
FS4-3-RPT	114639	FS4-3 w/test button	1.9 (0.9)
FS4-3Z	114410	FS4-3 w/ANSI terminal connections	1.9 (0.86)
FS4-3D	114550	FS4-3 w/2 SPDT switches	2.3 (1.0)
FS4-3S	114641	FS4-3 w/SS body, monel bellows	1.9 (0.9)
FS4-3SJ	176216	FS4-3S w/BSPT connections	1.9 (0.9)
FS4-3DS	114642	FS4-3S w/2 SPDT switches	3.3 (1.5)

Flow Switches – Liquid

Series FS8-W General Purpose Liquid Flow Switches

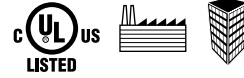

- For general purpose applications with environmental exposure, or those requiring a water-tight, dust tight, or a NEMA 4X rated flow switch
- 1" NPT
- Sealed Monel bellows
- Single pole, double throw snap switch
- Four stainless steel paddles included - 1", 2", 3" and 6" (25, 50, 80 and 150mm)
- Sensitivity adjusting screw makes flow adjustment easy
- Optional feature
 - BSPT threads
- Minimum temperature (fluid or ambient) 32°F (0°C)
- Maximum temperature 225°F (107°C)
- Maximum operating pressure 160 psi (11.3 kg/cm²)
- Replacement for NEMA 4X-style flow switches from Potter/Taco, Watts, Penn and other manufacturers



Series FS8-W

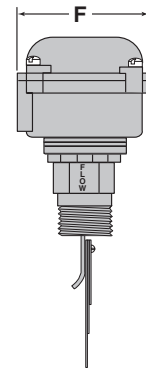
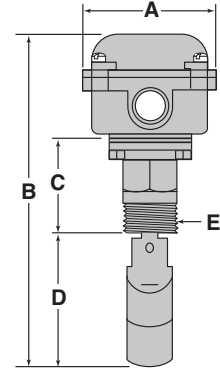

Electrical Ratings

Voltage	Motor Switch Rating (Amperes)		Pilot Duty
	Full Load	Locked Rotor	
120 VAC	7.4	44.4	125 VA at 120 or 240 VAC 50 or 60 cycles
240 VAC	3.7	22.2	

Dimensions, in. (mm)

A	B	C	D	E NPT	F
3¼ (83)	8⅝ (213)	2⅝ (59)	3⅞ (87)	1	3¼ (83)

Flow Rates

Pipe Size NPT in.	Settings	Mode of Operation				Max. Flow Rate gpm (lpm) w/o Paddle Damage
		Flow gpm (lpm)	Velocity fps (mps)	No Flow gpm (lpm)	Velocity fps (mps)	
1	Factory or Minimum	4.9 (18.5)	1.82 (.55)	3.4 (12.9)	1.25 (.38)	27
	Maximum	17.6 (66.6)	6.53 (2.00)	15 (56.8)	5.56 (1.69)	(102.2)
1¼	Factory or Minimum	7.5 (28.4)	1.60 (.49)	5.3 (20.1)	1.14 (.35)	47
	Maximum	29 (110)	6.23 (1.9)	24.6 (93.1)	5.28 (1.61)	(177.9)
1½	Factory or Minimum	9.4 (35.6)	1.48 (.45)	6.7 (25.4)	1.05 (.32)	63
	Maximum	37.8 (143)	5.95 (1.81)	32.2 (122)	5.07 (1.54)	(238.5)
2	Factory or Minimum	13.7 (51.8)	1.31 (.4)	9.4 (35.6)	.9 (.27)	105
	Maximum	56.4 (214)	5.39 (1.64)	47.4 (179)	4.53 (1.38)	(397.4)
2½	Factory or Minimum	17.9 (67.8)	1.20 (.36)	12.1 (45.8)	.81 (.25)	149
	Maximum	71.3 (270)	4.78 (1.46)	59.2 (224)	3.97 (1.21)	(564)
3	Factory or Minimum	24.2 (91.6)	1.05 (.32)	16.4 (62.1)	.71 (.22)	230
	Maximum	89 (337)	3.87 (1.18)	72.5 (274)	3.15 (.96)	(870.6)
4	Factory or Minimum	35.3 (134)	.89 (.27)	27 (102)	.68 (.21)	397
	Maximum	118 (446)	2.89 (.91)	105 (397)	2.64 (.8)	(1502.7)
5	Factory or Minimum	48.6 (184)	.78 (.24)	37.4 (142)	.6 (.18)	654
	Maximum	178 (674)	2.86 (.87)	160 (606)	2.57 (.78)	(2475.4)
6	Factory or Minimum	60.3 (228)	.67 (.20)	46.8 (177)	.52 (.16)	900
	Maximum	245 (927)	2.72 (.83)	225 (852)	2.5 (.76)	(3406.5)

Values are ± 10%

Ordering Information

Model Number	Part Number	Description	Weight lbs. (kg)
FS8-W	120601	General purpose flow switch w/NEMA 4X enclosure	2.0 (0.9)
FS8-WJ	120602	FS8-W w/BSPT connections	2.0 (0.9)
FS8-WZ	120605	FS8-W w/ANSI terminal connections	2.0 (0.9)
FS8-WJA	120751	FS8-WJ w/adjusting indicator	2.3 (1.0)

NOTE: DO NOT USE LIQUID FLOW SWITCHES ON SYSTEMS WITH FLOW GREATER THAN 10 FEET (3M) PER SECOND.

Flow Switches – Liquid

Series 250 General Purpose Liquid Flow Switches

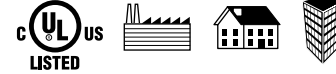

- Universal design serves the widest variety of applications
- For starting or stopping electrically operated equipment such as signal lights, alarms, motors, automatic burners, metering devices and others
- Replacement for common flow switches from Johnson/Penn, Potter/Taco, Watts, Hydrolevel and other manufacturers
- 1" NPTM Pipe Connection
- Sensitivity adjusting screw makes flow adjustment easy
- Single pole, double throw snap switch
- EPDM O-ring sealed
- Four stainless steel paddles included - 1", 2", 3" and 6" (25, 50, 80 and 150mm)
- Minimum temperature (fluid or ambient) 32°F (0°C)
- Maximum temperature 225°F (107°C)
- Maximum operating pressure 160 psi (11.3 kg/cm²)
- **Models:**
FS251 - NEMA1 enclosure
FS254 - NEMA4 enclosure

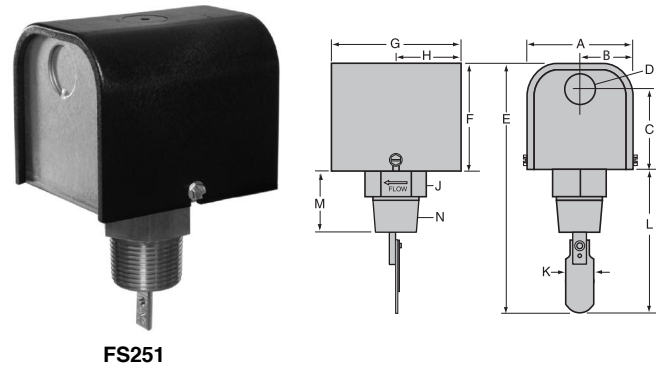

FS251

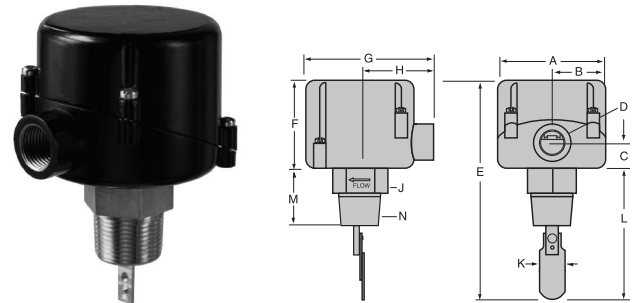

FS254

Dimensions, in. (mm)

	A	B	C	D	E	F	G
FS251	3 (76)	1½ (38)	2 ⁷ / ₃₂ (56)	7/8 (22)	8 ⁷ / ₁₆ (211)	2 ¹⁵ / ₁₆ (75)	3 ³ / ₈ (86)
FS254	3¼ (83)	1 ⁵ / ₈ (41)	¾ (19)	½ NPTF	8 ³ / ₈ (213)	2 ³ / ₄ (70)	3 ⁷ / ₈ (98)

	H	J	K	L	M	N	⁰ Turn-in Radius (not shown)
FS251	1 ¹¹ / ₁₆ (43)	1½ (38)	1 ¹ / ₈ (29)	3 ⁷ / ₁₆ (87)	2 ¹ / ₁₆ (52)	1" NPTM	2 ¹⁵ / ₁₆ (59)
FS254	2¼ (57)	1½ (38)	1 ¹ / ₈ (29)	3 ⁷ / ₁₆ (87)	1 ⁷ / ₈ (48)	1" NPTM	2 ¹⁵ / ₁₆ (59)

Flow Switches – Liquid

Series 250 (continued) General Purpose Liquid Flow Switches

Flow Rates

Pipe Size NPT in.	Settings	Mode of Operation		Max. Flow Rate gpm (lpm) w/o Paddle Damage
		Flow gpm (lpm)	No Flow gpm (lpm)	
1	Factory or Minimum	5.8 (22)	5.1 (19)	27
	Maximum	17.6 (66.6)	6.53 (2.00)	(102)
1¼	Factory or Minimum	6.7 (25)	6.0 (23)	47
	Maximum	19.1 (72)	18.0 (68)	(178)
1½	Factory or Minimum	8.4 (32)	7.0 (26)	63
	Maximum	25.3 (96)	24.1 (91)	(242)
2	Factory or Minimum	12.9 (49)	11.2 (42)	105
	Maximum	31.5 (119)	30.2 (114)	(397)
2½	Factory or Minimum	17.9 (68)	14.5 (55)	149
	Maximum	43.2 (164)	40.0 (151)	(564)
3	Factory or Minimum	26.2 (99)	20.2 (76)	230
	Maximum	54.9 (208)	49.8 (188)	(871)
4	Factory or Minimum	42.0 (159)	33.7 (128)	397
	Maximum	75.6 (286)	68.0 (257)	(1503)
5	Factory or Minimum	54.6 (207)	46.7 (177)	654
	Maximum	109.4 (414)	98.4 (372)	(2475)
6	Factory or Minimum	67.7 (256)	60.2 (228)	900
	Maximum	131.1 (496)	123.5(467)	(3407)

Values are ± 10%

Electrical Ratings

Voltage	Motor Switch Rating (Amperes)		Pilot Duty
	Full Load	Locked Rotor	
120 VAC	7.4	44.4	125 VA at 120 or 240 VAC 50 or 60 cycles
240 VAC	3.7	22.2	

Ordering Information

Model Number	Part Number	Description	Weight lbs. (kg)
FS-251	120611	General purpose flow switch – NEMA 1	1.9 (0.9)
FS-254	120610	General purpose flow switch – NEMA 4	1.9 (0.9)

NOTE: DO NOT USE LIQUID FLOW SWITCHES ON SYSTEMS WITH FLOW GREATER THAN 10 FEET (3M) PER SECOND.

Flow Switches – Liquid

Series FS7-4 Industrial Liquid Flow Switches



- Universal design serves the widest variety of large pipe applications, including heating and hydronic systems, air conditioning, refrigeration and process work
- 1 1/4" NPT
- Brass with sealed tube construction
- Single pole, double throw snap switch
- Magnetic switching mechanism eliminates need for bellows
- Sensitivity adjusting screw makes flow adjustment easy
- Paddles can be trimmed to suit application needs
- Optional features
 - Extended paddle arm - Model FS7-4L
 - Two SPDT switches to make or break two separate circuits
 - Stainless steel body and paddles
 - BSPT threads
- Minimum temperature (fluid or ambient) 32°F (0°C)
- Maximum temperature 300°F (149°C)
- Maximum operating pressure
 - 300 psi (21 kg/cm²)
 - 1000 psi (70 kg/cm²) – Stainless Steel models



Series FS7-4

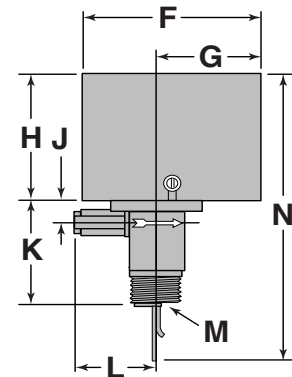
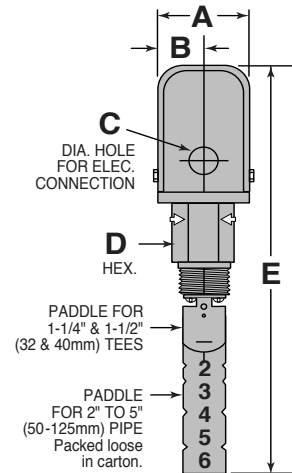

Electrical Ratings

Voltage	Motor Switch Rating (Amperes)		Pilot Duty
	Full Load	Locked Rotor	
120 VAC	7.4	44.4	125 VA at 120 or 240 VAC 50 or 60 cycles
240 VAC	3.7	22.2	

Dimensions, in. (mm)

A	B	C	D	E	F	G
2 7/8 (73)	1 7/16 (37)	7/8 (22)	1 3/4 (45)	13 9/16 (345)	5 13/16 (148)	3 3/8 (86)
H	J	K	L	M	N	
4 1/8 (105)	1 5/16 (24)	3 7/16 (87)	2 5/8 (67)	1 1/4 NPT	9 1/2 (241)	

Flow Rates

Model	Size NPT in.	Settings	Mode of Operation		Max. Flow Rate gpm (lpm) w/o Paddle Damage
			Flow gpm (lpm)	No Flow gpm (lpm)	
FS7-4	1 1/4	Factory or Minimum	4.8 (18.2)	3 (11.4)	47 (177.9)
		Maximum	7.7 (29.1)	5.9 (22.3)	
	1 1/2	Factory or Minimum	6.3 (23.8)	3.6 (13.6)	63 (238.5)
		Maximum	10 (37.9)	7 (26.5)	
	2	Factory or Minimum	9.9 (37.5)	5.9 (22.3)	105 (397.4)
		Maximum	15.8 (59.8)	11 (41.6)	
	2 1/2	Factory or Minimum	15.3 (57.9)	9.5 (36)	149 (564)
		Maximum	23.7 (89.7)	17 (64.3)	
	3	Factory or Minimum	24.4 (92.4)	15.4 (58.3)	230 (870.6)
		Maximum	35.5(134.4)	29.2(110.5)	
	4	Factory or Minimum	33.3 (126)	21.1 (79.9)	397 (1502.7)
		Maximum	61.4(232.4)	37.7(142.7)	
	5	Factory or Minimum	44.4(168.1)	31 (117.3)	654 (2475.4)
		Maximum	84 (317.9)	51 (193)	
	6	Factory or Minimum	56.3(213.1)	48.7(184.3)	900 (3406.5)
		Maximum	114.8(434.5)	71 (270.6)	
	8	Factory or Minimum	104(393.6)	89 (336.9)	1,500 (5677.5)
		Maximum	210(794.9)	131(495.8)	
	10	Factory or Minimum	184(696.4)	157(594.2)	2,500 (9462.5)
		Maximum	369 (1397)	231(874.3)	
12	Factory or Minimum	289 (1094)	247(934.9)	3,500 (13,247.5)	
	Maximum	582 (2203)	363 (1374)		
14	Factory or Minimum	387 (1465)	323 (1223)	4,000 (15,140)	
	Maximum	753 (2850)	495 (1874)		
16	Factory or Minimum	513 (1942)	428 (1620)	5,000 (18,925)	
	Maximum	998 (3777)	656 (2483)		
FS7-4L	20	Factory or Minimum	520 (1968)	260 (984)	8,000 (30,280)
		Maximum	780 (2952)	693 (2623)	
	24	Factory or Minimum	752 (2846)	376 (1423)	12,000 (45,420)
		Maximum	1128(4269)	1002(3793)	
	30	Factory or Minimum	1177(4455)	589 (2229)	20,200 (76,457)
		Maximum	1766(6684)	1570(5950)	
	36	Factory or Minimum	1723(6522)	861 (3259)	28,270 (107,002)
		Maximum	2584(9870)	2297(8694)	

Values are ± 10%

NOTE: DO NOT USE LIQUID FLOW SWITCHES ON SYSTEMS WITH FLOW GREATER THAN 10 FEET (3M) PER SECOND.

Ordering Information

Model Number	Part Number	Description	Weight lbs. (kg)
FS7-4	119700	Industrial flow switch	5.5 (2.5)
FS7-4D	119750	FS7-4 w/2 SPDT switches	5.5 (2.5)
FS7-4S	120160	FS7-4 w/SS body	5.0 (2.3)
FS7-4DS	119760	FS7-4S w/2 SPDT switches	5.0 (2.3)
FS7-4J	120060	FS7-4 w/ BSPT connections	5.5 (2.5)
FS7-4SJ	120171	FS7-4J w/SS body	5.0 (2.3)
FS7-4SDJ	120174	FS7-4SJ w/2 SPDT switches	5.0 (2.3)
FS7-4L	119900	FS7-4 w/extended paddle and paddle arm	5.5 (2.5)
FS7-4LJ	119980	FS7-4L w/ BSPT connections	5.7 (2.6)

Flow Switches – Liquid

Series FS7-4E Industrial Liquid Flow Switches

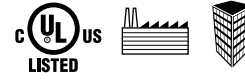

- For hazardous environment applications requiring a **NEMA 7 (Class I, Group C or D) or NEMA 9 Class II, Group E, F, or G** rated flow switch
- 1 1/4" NPT
- Brass with sealed tube construction
- Single pole, double throw snap switch
- Magnetic switching mechanism
- Sensitivity adjusting screw makes flow adjustment easy
- Paddles can be trimmed to suit application needs
- Optional features
 - Extended paddle arm
 - Stainless steel body and paddles
 - BSPT threads
- Minimum temperature (fluid or ambient) 32°F (0°C)
- Maximum temperature 300°F (149°C)
- Maximum operating pressure
 - 300 psi (21 kg/cm²)
 - 1000 psi (70 kg/cm²) – Stainless Steel models



Series FS7-4E

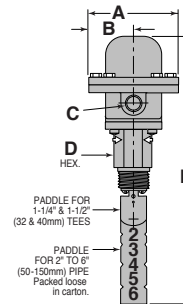
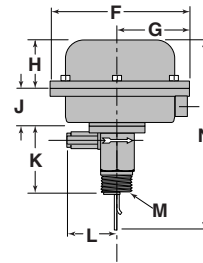

Electrical Ratings

Voltage	Motor Switch Rating (Amperes)		Pilot Duty
	Full Load	Locked Rotor	
120 VAC	7.4	44.4	125 VA at 120 or 240 VAC 50 or 60 cycles
240 VAC	3.7	22.2	

Dimensions, in. (mm)

A	B	C NPT	D	E	F	G
4 5/8 (117)	2 5/16 (59)	1/2	1 3/4 (45)	13 3/4 (350)	7 1/4 (184)	3 25/32 (96)
H	J	K	L	M NPT	N	
2 7/16 (62)	1 15/16 (50)	3 7/16 (87)	2 5/8 (67)	1 1/4	9 1/16 (246.6)	

Flow Rates

Pipe Size NPT in.	Settings	Mode of Operation		Max. Flow Rate gpm (lpm) w/o Paddle Damage
		Flow gpm (lpm)	No Flow gpm (lpm)	
1¼	Factory or Minimum	4.8 (18.2)	3 (11.4)	47 (177.9)
	Maximum	7.7 (29.1)	5.9 (22.3)	
1½	Factory or Minimum	6.3 (23.8)	3.6 (13.6)	63 (238.5)
	Maximum	10 (37.9)	7 (26.5)	
2	Factory or Minimum	9.9 (37.5)	5.9 (22.3)	105 (397.4)
	Maximum	15.8 (59.8)	11 (41.6)	
2½	Factory or Minimum	15.3 (57.9)	9.5 (36)	149 (564)
	Maximum	23.7 (89.7)	17 (64.3)	
3	Factory or Minimum	24.4 (92.4)	15.4 (58.3)	230 (870.6)
	Maximum	35.5 (134.4)	29.2 (110.5)	
4	Factory or Minimum	33.3 (126)	21.1 (79.9)	397 (1502.7)
	Maximum	61.4 (232.4)	37.7 (142.7)	
5	Factory or Minimum	44.4 (168.1)	31 (117.3)	654 (2475.4)
	Maximum	84 (317.9)	51 (193)	
6	Factory or Minimum	56.3 (213.1)	48.7 (184.3)	900 (3406.5)
	Maximum	114.8 (434.5)	71 (270.6)	
8*	Factory or Minimum	104 (393.6)	89 (336.9)	1,500 (5677.5)
	Maximum	210 (794.9)	131 (495.8)	
10*	Factory or Minimum	184 (696.4)	157 (594.2)	2,500 (9462.5)
	Maximum	369 (1397)	231 (874.3)	
12*	Factory or Minimum	289 (1094)	247 (934.9)	3,500 (13,247.5)
	Maximum	582 (2203)	363 (1374)	
14*	Factory or Minimum	387 (1465)	323 (1223)	4,000 (15,140)
	Maximum	753 (2850)	495 (1874)	
16*	Factory or Minimum	513 (1942)	428 (1620)	5,000 (18,925)
	Maximum	998 (3777)	656 (2483)	

Values are ± 10%

* Equipped with a 6" paddle

Ordering Information

Model Number	Part Number	Description	Weight lbs. (kg)
FS7-4E	120100	FS7-4 w/NEMA 7 & 9 enclosure	12.3 (5.6)
FS7-4EJ	120135	FS7-4E w/BSPT connections	12.7 (5.8)
FS7-4EL	120150	FS7-4E w/extended paddle & paddle arm	12.3 (5.6)
FS7-4ELJ	120158	FS7-4EL w/BSPT connections	12.7 (5.8)
FS7-4SE	120175	FS7-4S w/NEMA 7 & 9 enclosure	11.7 (5.3)
FS7-4SEJ	120186	FS7-4SE w/BSPT connections	12.0 (5.4)

NOTE: DO NOT USE LIQUID FLOW SWITCHES ON SYSTEMS WITH FLOW GREATER THAN 10 FEET (3M) PER SECOND.

Flow Switches – Liquid

Series FS7-4W Industrial Liquid Flow Switches



- For applications requiring a water-tight, dust-tight or a **NEMA 4X** rated flow switch
- 1 1/4" NPT
- Brass with sealed tube construction
- Single pole, double throw snap switch
- Magnetic switching mechanism eliminates need for bellows
- Sensitivity adjusting screw makes flow adjustment easy
- Paddles can be trimmed to suit application needs
- Optional features
 - Extended paddle arm
 - Stainless steel body and paddles
 - BSPT threads
- Minimum temperature (fluid or ambient) -65°F (-54°C)
- Maximum temperature 300°F (149°C)
- Maximum operating pressure
 - 300 psi (21 kg/cm²)
 - 1000 psi (70 kg/cm²) – Stainless Steel models



Series FS7-4W

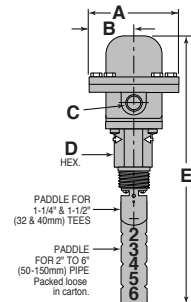
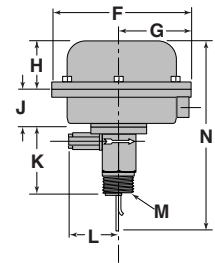

Electrical Ratings

Voltage	Motor Switch Rating (Amperes)		Pilot Duty
	Full Load	Locked Rotor	
120 VAC	7.4	44.4	125 VA at 120 or 240 VAC 50 or 60 cycles
240 VAC	3.7	22.2	

Dimensions, in. (mm)

A	B	C NPT	D	E	F	G
4 5/8 (117)	2 5/16 (59)	1/2	1 3/4 (45)	13 3/4 (350)	7 1/4 (184)	3 25/32 (96)
H	J	K	L	M NPT	N	
2 7/16 (62)	1 5/16 (50)	3 7/16 (87)	2 5/8 (67)	1 1/4	9 11/16 (246.6)	

Flow Rates

Pipe Size NPT in.	Settings	Mode of Operation		Max. Flow Rate gpm (lpm) w/o Paddle Damage
		Flow gpm (lpm)	No Flow gpm (lpm)	
1¼	Factory or Minimum	4.8 (18.2)	3 (11.4)	47 (177.9)
	Maximum	7.7 (29.1)	5.9 (22.3)	
1½	Factory or Minimum	6.3 (23.8)	3.6 (13.6)	63 (238.5)
	Maximum	10 (37.9)	7 (26.5)	
2	Factory or Minimum	9.9 (37.5)	5.9 (22.3)	105 (397.4)
	Maximum	15.8 (59.8)	11 (41.6)	
2½	Factory or Minimum	15.3 (57.9)	9.5 (36)	149 (564)
	Maximum	23.7 (89.7)	17 (64.3)	
3	Factory or Minimum	24.4 (92.4)	15.4 (58.3)	230 (870.6)
	Maximum	35.5 (134.4)	29.2 (110.5)	
4	Factory or Minimum	33.3 (126)	21.1 (79.9)	397 (1502.7)
	Maximum	61.4 (232.4)	37.7 (142.7)	
5	Factory or Minimum	44.4 (168.1)	31 (117.3)	654 (2475.4)
	Maximum	84 (317.9)	51 (193)	
6	Factory or Minimum	56.3 (213.1)	48.7 (184.3)	900 (3406.5)
	Maximum	114.8 (434.5)	71 (270.6)	
8*	Factory or Minimum	104 (393.6)	89 (336.9)	1,500 (5677.5)
	Maximum	210 (794.9)	131 (495.8)	
10*	Factory or Minimum	184 (696.4)	157 (594.2)	2,500 (9462.5)
	Maximum	369 (1397)	231 (874.3)	
12*	Factory or Minimum	289 (1094)	247 (934.9)	3,500 (13,247.5)
	Maximum	582 (2203)	363 (1374)	
14*	Factory or Minimum	387 (1465)	323 (1223)	4,000 (15,140)
	Maximum	753 (2850)	495 (1874)	
16*	Factory or Minimum	513 (1942)	428 (1620)	5,000 (18,925)
	Maximum	998 (3777)	656 (2483)	

Values are ± 10%

* Equipped with a 6" paddle

Ordering Information

Model Number	Part Number	Description	Weight lbs. (kg)
FS7-4W	120201	FS7-4 w/NEMA 4X enclosure	12.3 (5.6)
FS7-4SW	120191	FS7-4W w/SS body	11.7 (5.3)
FS7-4WJ	120261	FS7-4W w/BSPT connections	12.3 (5.6)
FS7-4SWJ	120197	FS7-4SW w/BSPT connections	11.7 (5.3)
FS7-4WL	120301	FS7-4W w/extended paddle & paddle arm	12.7 (5.8)
FS7-4WLJ	120361	FS7-4WL w/BSPT connections	12.7 (5.8)

NOTE: DO NOT USE LIQUID FLOW SWITCHES ON SYSTEMS WITH FLOW GREATER THAN 10 FEET (3M) PER SECOND.

“K” Factors – adjusting paddle length

If the flow rate in the pipe exceeds the maximum adjustment on the Flow Switch a change can be made in the paddle length. Modifying the paddle length is a simple procedure that will adapt this equipment to a broader range of applications. Use the following formula as a guide when changing paddle lengths

$$\text{Paddle Length} = \frac{K}{\text{Flow Rate (GPM)}}$$

FS4-3 Example A

Calculate paddle length to provide switch action when flow in a 3 inch pipe increases to 100 GPM (366 LPM)

Use Maximum Adjustment Flow

$$L = \frac{162.5}{100} = 1.625 \text{ in. (41.27mm)}$$

FS7-4 Example B

Calculate paddle length to provide switch action when flow in a 3 inch pipe increases to 100 GPM (366 LPM)

Use Maximum Adjustment Flow

$$L = \frac{92.94}{100} = .93 \text{ in. (23.62mm)}$$

FS7-4 Example C

Calculate paddle length to provide switch action when flow in a 12 inch pipe decreases to 1200 GPM (4392 LPM)

Use Maximum Adjustment No-Flow

$$L = \frac{2439.8}{1200} = 2.033 \text{ in. (51.63mm)}$$

FS8W Example D

Calculate paddle length to provide switch action when flow in a 4 inch pipe increases to 200 GPM (732 LPM)

Use Maximum Adjustment Flow

$$L = \frac{442}{200} = 2.21 \text{ in. (56.13mm)}$$

FS4-3 “K” Factor

Pipe Size NPT in.	Flow Maximum Adjustment	No-Flow Maximum Adjustment
2	69.2	50.3
2½	102.2	81.0
3	162.5	143.5
4	276.0	241.0
5	550.0	440.0
6	977.0	728.0

FS7-4 “K” Factor

Pipe Size NPT in.	Flow Maximum Adjustment	No-Flow Maximum Adjustment
2	34.63	30.43
2½	54.00	47.46
3	92.94	81.69
3½	133.67	117.49
4	183.35	161.15
5	322.61	283.55
6	510.70	448.87
7	705.05	619.67
8	1014.47	891.62
9	1302.47	1144.79
10	1791.70	1574.74
12	2776.04	2439.88
14	3729.02	3255.02
16	4869.81	4250.81
18	6164.08	5380.57
20	7661.11	6687.31
30	18202.0	15888.0

FS8-W “K” Factor

Pipe Size NPT in.	Flow Maximum Adjustment	No-Flow Maximum Adjustment
2	118.5	99.5
2½	168.9	141.8
3	278.0	227.0
4	442.0	391.0
5	847.0	762.0
6	1440.0	1325.0

Flow Switches – Liquid

Series FS5 General Purpose Liquid Flow Switches

- For general purpose applications requiring low flow rate sensitivity
- In-line configuration eliminates need for a pipe tee
- Sizes available
 - 3/4" NPT
 - 1" NPT
- Materials of construction
 - Brass, carbon & EPDM elastomer (for water); Models FS5 & FS5-D
 - Stainless steel, carbon & Buna N (for water or water and petroleum base compounds) Models FS5-S & FS5-DS
- Single pole, double throw snap switch
- Sensitivity adjusting screw makes flow adjustment easy
- Optional feature
 - BSPT threads
- Minimum temperature (fluid or ambient) 32°F (0°C)
- Maximum temperature
 - 225°F (107°C) – Stainless Steel models
 - 250°F (121°C) – Brass
- Maximum operating pressure 150 psi (10.5 kg/cm²)

Electrical Ratings

Voltage	Motor Switch Rating (Amperes)		Pilot Duty
	Full Load	Locked Rotor	
120 VAC	7.4	44.4	125 VA at 120 or 240 VAC 50 or 60 cycles
240 VAC	3.7	22.2	

Ordering Information

Model Number	Part Number	Description	Weight lbs. (kg)
FS5-3/4	114760	General purpose flow switch 3/4" NPT	2.5 (1.1)
FS5-D-3/4	114763	FS5-3/4 w/2 SPDT switches	2.5 (1.1)
FS5-J-3/4	114765	FS5-3/4 w/BSPT connections	2.5 (1.1)
FS5-1	114780	General purpose flow switch 1" NPT	2.5 (1.1)
FS5-D-1	114783	FS5-1 w/2 SPDT switches	2.5 (1.1)
FS5-J-1	114785	FS5-1 w/BSPT connections	2.5 (1.1)
FS5-S-1	114795	FS5-1 w/SS body	2.3 (1.0)
FS5-DS-1	114793	FS5-1 w/SS body, 2 SPDT switches	2.5 (1.1)

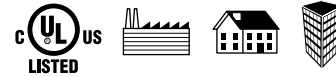

Series FS5

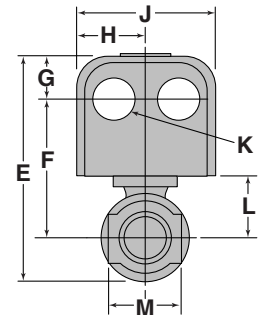
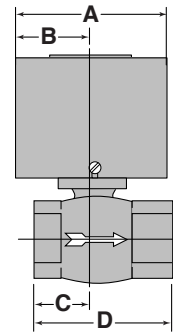

Dimensions, in. (mm)

A	B	C	D
3 ⁷ / ₁₆ (87)	1 ⁹ / ₁₆ (40)	1 ⁵ / ₁₆ (33)	3 ³ / ₁₆ (56)

E	F	G	H
5 ¹ / ₁₆ (129)	3 ¹ / ₄ (83)	7 ⁸ / ₁₆ (22)	1 ¹⁹ / ₃₂ (40.5)

J	K	L	M
3 ³ / ₁₆ (81)	7 ⁸ / ₁₆ (22)	1 ³ / ₈ (35)	1 ¹¹ / ₁₆ (43)

Flow Rates

Pipe Size NPT in.	Settings	Mode of Operation		Max. Flow Rate gpm (lpm) w/o Paddle Damage
		Flow gpm (lpm)	No Flow gpm (lpm)	
3/4 or 1	Factory or Minimum	1.5 (5.7)	1.1 (4.2)	16.62 (62.9)
	Maximum	15 (56.8)	10 (37.9)	27 (102.2)

Values are ± 10%

NOTE: DO NOT USE LIQUID FLOW SWITCHES ON SYSTEMS WITH FLOW GREATER THAN 10 FEET (3M) PER SECOND.

Flow Switches – Liquid

Series FS1 High Sensitivity Liquid Flow Switches



- For general purpose applications where high sensitivity is required and moderate or low flow rates are encountered such as air conditioning, heating and hydronic systems, water, fuel oil, some viscous liquids and oils in process work
- In-line configuration eliminates need for a pipe tee
- High flow capacity
- 1/2" NPT
- Single pole, double throw snap switch
- Switch compartment is completely sealed to protect it from the liquid
- Sensitivity adjusting screw makes flow adjustment easy
- Optional feature
 - BSPT threads
- Minimum temperature (fluid or ambient) 32°F (0°C)
- Maximum temperature 225°F (107°C)
- Maximum operating pressure 100 psi (7 kg/cm²)



Series FS1

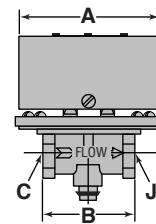
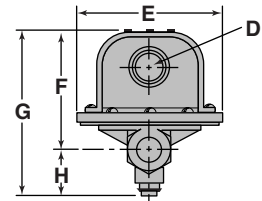

Electrical Ratings

Voltage	Motor Switch Rating (Amperes)		Pilot Duty
	Full Load	Locked Rotor	
120 VAC	7.4	44.4	125 VA at 120 or 240 VAC 50 or 60 cycles
240 VAC	3.7	22.2	

Dimensions, in. (mm)

A	B	C NPT	D	E	F	G	H	J NPT
3/4 (95)	2 5/8 (67)	1/2	7/8 (22)	3 13/16 (97)	3 3/16 (81)	4 7/16 (113)	1 1/4 (32)	1/2

NOTE: DO NOT USE LIQUID FLOW SWITCHES ON SYSTEMS WITH FLOW GREATER THAN 10 FEET (3M) PER SECOND.

Flow Switches – Liquid

Model FS1-W High Sensitivity Liquid Flow Switches

- For applications requiring a water-tight, dust-tight, or a NEMA 4X rated flow switch



Model FS1-W

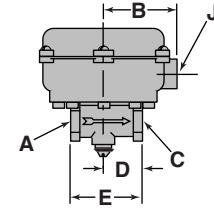

Dimensions, in. (mm)

A NPT	B	C NPT	D	E
1/2	2 5/8 (67)	1/2	1 3/8 (35)	2 5/8 (67)
F	G	H	J NPT	
3 7/16 (87)	5 1/2 (140)	1 1/4 (32)	1/2 (15)	

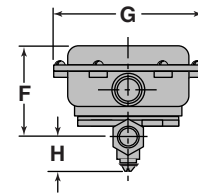

Ordering Information

Model Number	Part Number	Description	Weight lbs. (kg)
FS1	113200	High sensitivity flow switch - 1/2" NPT body	3.0 (1.4)
FS1-J	113550	FS1 w/BSPT connections	3.3 (1.5)
FS1-W	113601	FS1 w/NEMA 4X enclosure	3.5 (1.6)

Flow Rates

Settings	Mode of Operation		Max. Flow Rate gpm (lpm)
	Flow gpm (lpm)	No Flow gpm (lpm)	
Factory or Minimum	0.41 (1.55)	0.24 (.91)	25 (95)
Maximum	1.81 (6.85)	1.28 (4.84)	

Values are ± 10%

NOTE: DO NOT USE LIQUID FLOW SWITCHES ON SYSTEMS WITH FLOW GREATER THAN 10 FEET (3M) PER SECOND.

Flow Switches – Liquid

Series FS6 High Sensitivity Liquid Flow Switches

- For heavy duty applications where high sensitivity is required, such as water treatment systems, cooling systems for electronic circuits, compressors, booster pumps, and bearings, and other applications that need instant switching
- In-line configuration eliminates need for a pipe tee
- Very high flow capacity
- Actuates at extremely low flow rate
- Sizes available
 - 3/4" NPT
 - 1" NPT
- Single pole, double throw snap switch
- Switch compartment is completely sealed to protect it from the liquid
- Sensitivity adjusting screw makes flow adjustment easy
- Optional feature
 - BSPT threads
- Minimum temperature (fluid or ambient) 32°F (0°C)
- Maximum temperature 225°F (107°C)
- Maximum operating pressure 100 psi (7 kg/cm²)



Series FS6

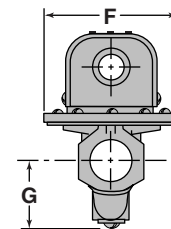
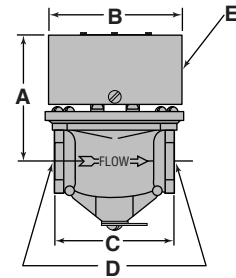

Dimensions, in. (mm)

A	B	C	D NPT	E	F	G
3 1/2 (89)	3 23/32 (94.4)	3 3/8 (86)	3/4 or 1	7/8 (22)	3 3/4 (95)	2 (51)

Model FS6-W High Sensitivity Liquid Flow Switches

- For applications requiring a water-tight, dust-tight, or a NEMA 4X rated flow switch



Model FS6-W

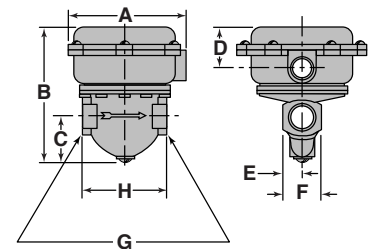

Dimensions, in. (mm)

A	B	C	D	E	F	G NPT	H
5 (127)	5 3/4 (146)	2 (51)	1 5/8 (41)	2 9/32 (23)	1 13/16 (46)	3/4 or 1	3 3/8 (86)

Electrical Ratings

Voltage	Motor Switch Rating (Amperes)		Pilot Duty
	Full Load	Locked Rotor	
120 VAC	7.4	44.4	125 VA at 120 or 240 VAC 50 or 60 cycles
240 VAC	3.7	22.2	

Flow Rates

Pipe Size NPT in.	Settings	Mode of Operation		Max. Flow Rate gpm (lpm)
		Flow gpm (lpm)	No Flow gpm (lpm)	
3/4 or 1	Factory or			
	Minimum	.12 (.45)	.06 (.23)	16.62 (629)
	Maximum	2.5 (9.46)	1.5 (5.68)	27 (102.2)

Values are ± 10%

Ordering Information

Model Number	Part Number	Description	Weight lbs. (kg)
FS6-3/4	115400	High sensitivity flow switch 3/4" NPT body	4.5 (2)
FS6-J-3/4	115550	FS6-3/4 w/BSPT pipe threads	4.5 (2)
FS6-1	115600	High sensitivity flow switch 1" NPT body	4.5 (2)
FS6-J-1	115650	FS6-1 w/BSPT pipe threads	4.5 (2)
FS6-W-3/4	115651	FS6-3/4 w/NEMA 4X enclosure	4.5 (2)
FS6-WJ-3/4	115653	FS6-W-3/4 w/BSPT connections	4.5 (2)
FS6-W-1	115652	FS6-1 w/NEMA 4X enclosure	4.5 (2)
FS6-WJ-1	115654	FS6-W-1 w/BSPT connections	4.5 (2)

NOTE: DO NOT USE LIQUID FLOW SWITCHES ON SYSTEMS WITH FLOW GREATER THAN 10 FEET (3M) PER SECOND.

Flow Switches – Liquid

Series FS4-3T General Purpose Liquid Flow Switches

- For starting or stopping electrically operated equipment such as signal lights, alarms, motors, automatic burners, metering devices and others
- In-line configuration eliminates need for a pipe tee
- Sizes available
 - 3/4" NPT
 - 1" NPT
- Paddles available for low, medium or high flow
- Two electrical knock-outs allows connection from either end
- Sensitivity adjusting screw makes flow adjustment easy
- Single pole, double throw snap switch
- Hardened stainless steel bearings minimize friction
- Sealed Monel bellows
- Minimum temperature (fluid or ambient) 32°F (0°C)
- Maximum temperature 300°F (149°C)
- Maximum pressure 160 psi (11.3 kg/cm²)

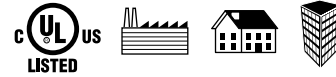

Series FS4-3T

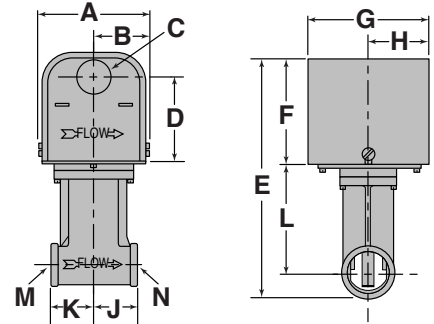

NOTE: DO NOT USE LIQUID FLOW SWITCHES ON SYSTEMS WITH FLOW GREATER THAN 10 FEET (3M) PER SECOND.

Ordering Information

Model Number	Part Number	Description	Weight lbs. (kg)
FS4-3T1-3/4	114800	3/4" NPT body - high flow rate	3 (1.4)
FS4-3T2-3/4	114900	3/4" NPT body - medium flow rate	3 (1.4)
FS4-3T3-3/4	115000	3/4" NPT body - low flow rate	3 (1.4)
FS4-3T1-1	115100	1" NPT body - high flow rate	3 (1.4)
FS4-3T2-1	115200	1" NPT body - medium flow rate	3 (1.4)
FS4-3T3-1	115300	1" NPT body - low flow rate	3 (1.4)

Electrical Ratings

Voltage	Motor Switch Rating (Amperes)		Pilot Duty
	Full Load	Locked Rotor	
120 VAC	7.4	44.4	125 VA at 120 or 240 VAC 50 or 60 cycles
240 VAC	3.7	22.2	

Dimensions, in. (mm)

A	B	C	D	E	F	G
3 (76)	1 1/2 (38)	7/8 (22)	2 7/32 (56)	6 7/8 (175)	2 15/16 (75)	3 3/8 (86)
H	J	K	L	M	N	
1 11/16 (43)	1 5/16 (33)	1 1/8 (29)	3 1/16 (78)	NPT 3/4 or 1	NPT 3/4 or 1	

Flow Rates

Pipe Model Number	Size NPT in.	Settings	Mode of Operation		Max. Flow Rate gpm (lpm) w/o Paddle Damage
			Flow gpm (lpm)	No Flow gpm (lpm)	
FS4-3T1-3/4	3/4	Factory or Minimum	4.4 (16.7)	2.6 (9.8)	16.62 (62.9)
		Maximum	10.5(39.7)	9.8(37.1)	
FS4-3T2-3/4	3/4	Factory or Minimum	3.7 (14)	2.2 (8.3)	
		Maximum	8.9 (33.7)	8.3(31.4)	
FS4-3T3-3/4	3/4	Factory or Minimum	2 (7.6)	1.2 (4.5)	
		Maximum	4.5 (17)	4.1(15.5)	
FS4-3T1-1	1	Factory or Minimum	5 (18.9)	3.2(12.1)	27 (102.2)
		Maximum	11.5(43.5)	11(41.6)	
FS4-3T2-1	1	Factory or Minimum	4.8 (18.1)	2.9 (11)	
		Maximum	10.1(38.2)	9.4(35.6)	
FS4-3T3-1	1	Factory or Minimum	2 (7.6)	1.2 (4.5)	
		Maximum	4.5 (17)	4.1(15.5)	

Values are ± 10%

Air Flow Switches

McDonnell & Miller Air Flow Switches sense air flow or no air flow by responding only to velocity of air movement. They provide a positive and economical way to detect change or loss of air flow velocity caused by closed damper or fan inlet, a loose fan wheel, a slipped or broken fanbelt, a dirty or clogged filter, or an overload on a fan motor switch.

The Series AF1 flow switches are designed for medium and higher velocity systems. Models AF2 and AF3 are for systems with lower air flow velocities.

Air flow switches can be used for a variety of applications such as, but not limited to:

- Clean Room Filter Systems
- Duct Type Heating
- Exhaust Ventilating
- Air Supply System
- Air Treatment Systems

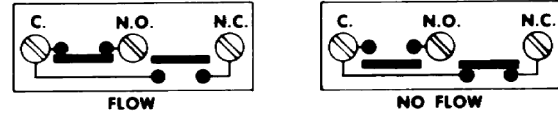

In the tables of flow rates included in this catalog, the word “Flow” means that switch will close one circuit and open the other, when flow rate is increased to the rate shown.

The words “No-Flow” mean the switch will reverse position—open first circuit and close the second—when flow rate is decreased to the rate shown.

Flow Switches	NEMA Enclosure
All Models	Type 1—General purpose indoor
AFE1	Type 7—Hazardous Location (Class 1—Group C or D) Type 9—Hazardous Location (Class 2—Group E,F or G)

Model AFE1 Flow Switches are Underwriters Laboratories Inc. Listed for use in these hazardous locations:

Class I, Division I, Group C – Atmospheres containing ethylether vapors, ethylene or cyclopropane.

Class I, Division I, Group D – Atmospheres containing gasoline, petroleum. naphtha, benzene, butane, propane, alcohols, acetone, benzol, lacquer solvent vapors or natural gas.

Class II, Division I, Group E – Atmospheres containing dust of aluminum, magnesium or their commercial alloys.

Class II, Division I, Group F – Atmospheres containing carbon black, coal or coke dust.

Class II, Division I, Group G – Atmospheres containing flour, starch or grain dusts.

Note: For other listings contact the factory.

Air Flow

$$\text{Cubic Feet Per Minute (CFM)} \dots\dots\dots \text{Duct Area} \times \text{FPM}$$

$$\text{FPM} \dots\dots\dots \frac{\text{CFM}}{\text{Duct Area}}$$

$$\text{One Square Foot} = (12'' \times 12'' = 144 \text{ sq. In.})$$

Flow Switches

How To Select Air Flow Switches

1. What function will the flow switch perform?

McDonnell & Miller Air Flow Switches are equipped with single pole double throw switches; consequently, they can be used to make or break an electrical circuit either when flow starts or when flow stops. For example, the Flow Switch can be used to:

- Actuate a signal when flow stops
- Start a motor with flow
- Shut off an alarm when flow is adequate
- Stop a motor with no flow

2. How much flow is present?

The air flow velocity at which the Air Flow Switch is to respond should be determined first. McDonnell & Miller Air Flow Switches are actuated (make or break) with an increase in velocity and will reverse switch position (break or make) with a decrease in velocity. The term "Flow" represents the actual movement of air (velocity) within a duct sufficient to actuate the switch. The term "No Flow" represents a decrease in velocity or a total air flow stoppage, which will permit the switch to return back to the original position.

IMPORTANT: In operation the switch must be actuated by "Flow" before it can be reversed again by "No-Flow". All McDonnell Flow Switches can easily be adjusted to require a higher actuating "Flow" or "No-Flow".

3. Size of duct

McDonnell & Miller Air Flow Switches are designed for installation in ducts six inches (150mm) and larger.

4. Maximum temperature

Air temperature inside and outside of the duct should be considered. Different McDonnell & Miller Air Flow Switches can be used at temperatures from 32°F (0°C) up to 300°F (149°C).

5. Maximum Velocities

The Series AF1 is designed for medium and higher velocity applications up to 2500 fpm (12.7mps). The Models AF2, AF3, and AF3-D are designed for lower air flow velocities with a maximum of 2000 fpm (10.2mps).

6. Type of air

Depending on the model, McDonnell & Miller Air Flow Switches have brass, steel, aluminum, stainless steel, Viton and PTFE parts exposed to the inside of the duct. In addition to use with normal air, they may be used in applications where certain chemical fumes or other airborne elements are present.

7. Installation

It is recommended that all models be located in a horizontal duct, 10 duct diameters downstream from fan or 7 duct diameters downstream from an elbow, junction or other cause of turbulence.

Often the actual flow rates in the duct appreciably exceed the flow rate required to actuate the switch. If the flow switch must be located closer than 10 duct diameters from a fan, it is recommended that the flow switch be installed on the suction side of the fan.

For air flow applications, the air flow switch should be mounted 7 duct diameters downstream of a flow obstruction like an elbow; 10 duct diameters downstream of a blower.

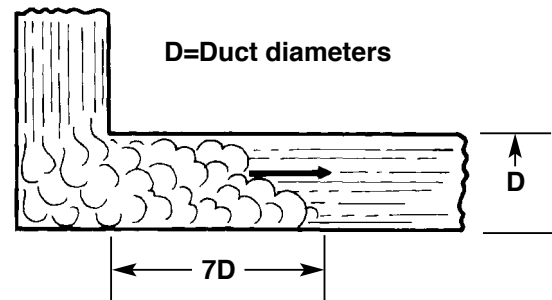

Air Flow Switch Specifications – Horizontal Mounting

Model Number	Operating Velocity Range for Horizontal Installation fpm (mpm)	Maximum Allowable Operating Velocity fpm (mpm)	Vane Material	Seal Material	Seal Strength	Enclosure	Switch	Maximum Air Temperature °F (°C)
AF1	480 - 2230 (146 - 680)	2500 (762)	Brass, Steel	Chrome PTFE	Low	General Purpose Indoor	SPDT	300 (149)
AF1-S	480 - 2230 (146 - 680)	2500 (762)	Stainless Steel 18-8,302 &316	Viton	Medium	General Purpose Indoor	SPDT	300 (149)
AFE-1	350-1900 (107 - 579)	2000 (610)	Brass, Stainless Steel Aluminum	Magnetic Insulation	High	Hazardous Duty Class I & II	SPDT	275 (135)
AF2	380-1250 (116 - 381)	2000 (610)	Brass, Steel, Aluminum	Chrome PTFE	Low	General Purpose Indoor	SPDT	300 (149)
AF3	235-1445 (72 - 440)	2000 (610)	Brass, Steel, Aluminum	Chrome PTFE	Low	General Purpose Indoor	SPDT	275 (135)
AF3-D	295-1445 (90 - 440)	2000 (610)	Brass, Steel, Aluminum	Chrome PTFE	Low	General Purpose Indoor	DPDT	275 (135)

Flow Velocities

Model Number

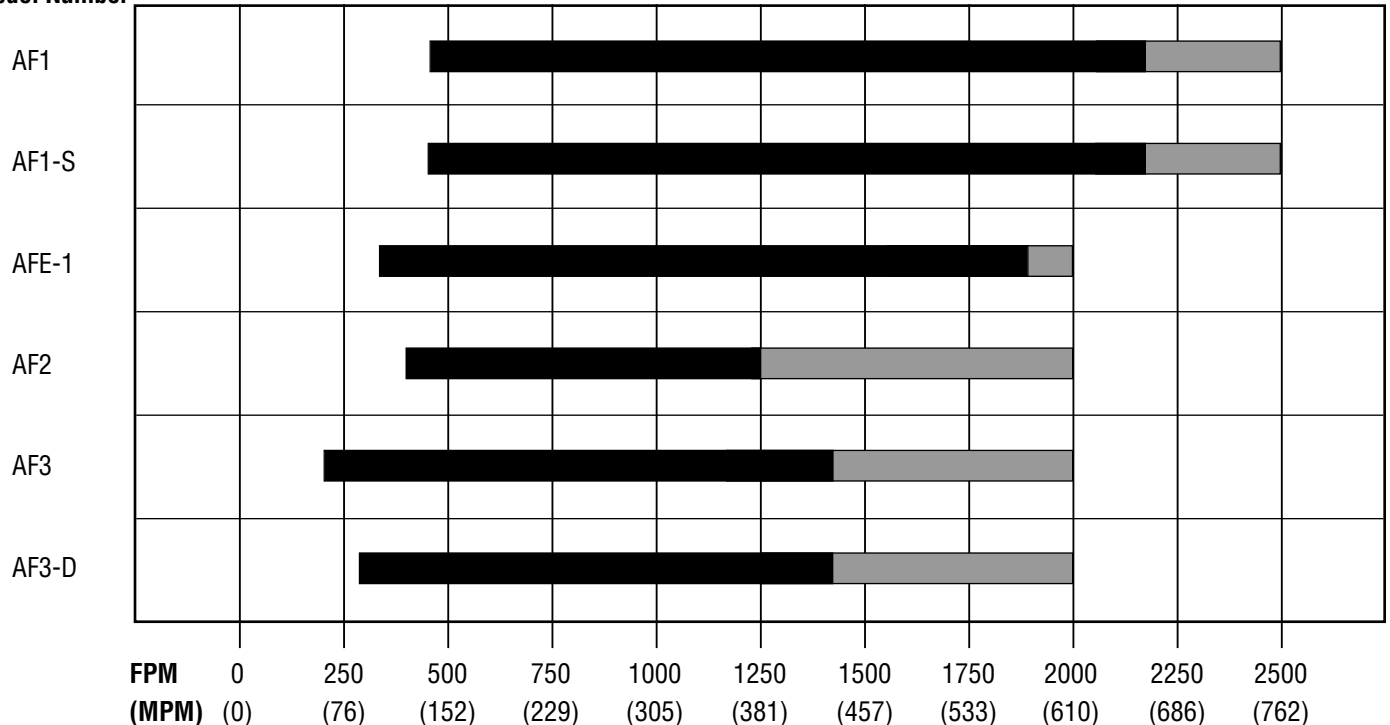

Operating Velocity Range
 Maximum Allowable Operating Velocity Range

How to Select Air Flow Switches (continued)

Mounting Methods – Horizontal Ducts

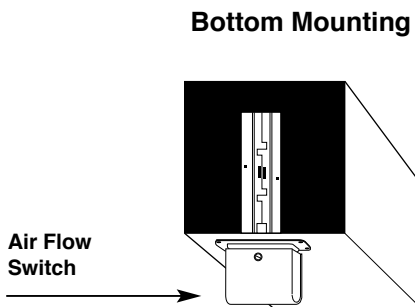
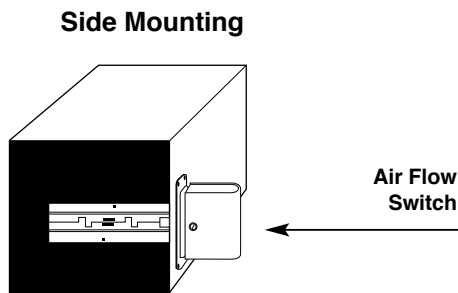
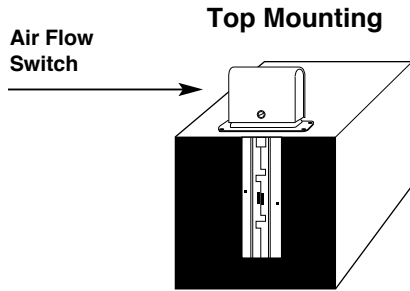

Vertical Duct (Upward Flow)

Model Number	Settings	Mode of Operation	
		Flow fpm (mpm)	No Flow fpm (mpm)
AF1 Standard 7 1/4" (184mm)	Factory or Minimum	910 (277)	785 (239)
	Maximum	1610 (491)	1460 (445)
AF1 Trimmed 2" (51mm) 5 1/4" (133)	Factory or Minimum	1235 (376)	1050 (320)
	Maximum	2560 (780)	2410 (735)
AF3	Factory or Minimum	450 (137)	430 (131)
	Maximum	1470 (448)	1395 (425)
AF3-D	Factory or Minimum	560 (171)	540 (165)
	Maximum	1470 (448)	1030 (314)

Based on Standard Air 0.075 pounds per Cubic Foot (1.205 kg/m³)
Values are ± 10%
Consult factory for downward flow

Density of Air as a Function of Temperature

Based on Standard Air			
Temperature		Density	
°F	°C	lbs./ft ³	kg/m ³
-40	-40	.094	1.515
-4	-20	.087	1.395
32	0	.080	1.293
50	10	.078	1.248
68	20	.075	1.205
86	30	.072	1.165
104	40	.070	1.128
140	60	.066	1.060
176	80	.062	1.000
212	100	.059	.946
392	200	.046	.746

Installing the air flow switch in a horizontal duct is recommended. However, if the velocity of air flow exceeds the flow rates shown in the Vertical Duct Chart to the right, the air flow switch may be installed in a vertical duct with **upward** air flow.

Flow Switches – Air

Series AF1 Air Flow Switches

- For general purpose applications with medium and high velocity requirements
- Paddle fits 8" (203mm) minimum duct size, or 6" (152mm) if trimmed
- Brass, steel and aluminum construction
- Single pole, double throw snap switch
- Sensitivity adjusting screw makes flow adjustment easy
- Two electrical knock-outs allow connection from either end
- Can be equipped with a time delay relay
- Optional features
 - Stainless steel
- Minimum ambient temperature 32°F (0°C)
- Maximum duct temperature 300°F (149°C)

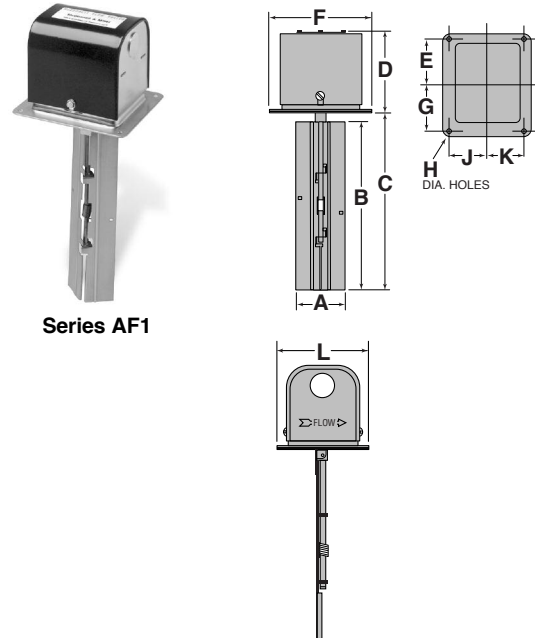

Ordering Information

Model Number	Part Number	Description	Weight lbs. (kg)
AF1	122800	Air flow switch	2.0 (.9)
AF1-S	123000	AF1 w/SS paddle	2.0 (.9)

Electrical Ratings

Voltage	Motor Switch Rating (Amperes)		Pilot Duty
	Full Load	Locked Rotor	
120 VAC	7.4	44.4	125 VA at 120 or 240 VAC 50 or 60 cycles
240 VAC	3.7	22.2	

Dimensions, in. (mm)

A	B	C	D	E	F
2 ¹ / ₈ (54)	7 ⁵ / ₁₆ (186)	7 ²³ / ₃₂ (196)	3 ⁷ / ₁₆ (16)	1 ²⁹ / ₃₂ (48.4)	4 ³ / ₈ (111)

G	H	J	K	L
1 ²⁹ / ₃₂ (48.4)	3 ³ / ₁₆ (4.8)	1 ¹⁹ / ₃₂ (40.5)	1 ¹⁹ / ₃₂ (40.5)	3 ¹³ / ₁₆ (48.4)

Flow Rates – feet per minute (meters per minute)

Horizontal Duct (Recommended Installation)

Paddle Length	Settings	Mode of Operation	
		Flow fpm (mpm)	No Flow fpm (mpm)
Standard 7 ¹ / ₄ " (184mm)	Factory or Minimum	480 (146)	185 (56)
	Maximum	1385 (422)	1160 (354)
Trimmed 2" (51mm) 5 ¹ / ₄ " (133mm)	Factory or Minimum	700 (213)	220 (67)
	Maximum	2230 (680)	1820 (555)

Based on Standard Air 0.075 pounds per Cubic Foot (1.205 kg/m³)
 Values are ± 10%

Vertical Duct (Upward Flow)

Paddle Length	Settings	Mode of Operation	
		Flow fpm (mpm)	No Flow fpm (mpm)
Standard 7 ¹ / ₄ " (184mm)	Factory or Minimum	910 (277)	785 (239)
	Maximum	1610 (491)	1460 (445)
Trimmed 2" (51mm) 5 ¹ / ₄ " (133mm)	Factory or Minimum	1235 (376)	1050 (320)
	Maximum	2560 (780)	2410 (735)

Based on Standard Air 0.075 pounds per Cubic Foot (1.205 kg/m³)
 Values are ± 10%

Flow Switches – Air

Series AFE-1

Air Flow Switches

- For industrial hazardous environment applications requiring a **NEMA 7 (Class I, Division I, Group C and D) or NEMA 9 (Class II, Division I, Group E, F, and G)** rated flow switch for medium velocity
- ½" NPT conduit connection
- Paddle fits 8" (203mm) minimum duct size
- Brass, steel and aluminum construction
- Single pole, double throw snap switch
- Magnetic switching mechanism eliminates need for bellows
- Sensitivity adjusting screw makes flow adjustment easy
- Maximum ambient temperature 120°F (49°C)
- Maximum duct temperature 275°F (135°C)

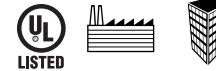

Series AFE-1

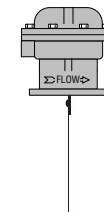
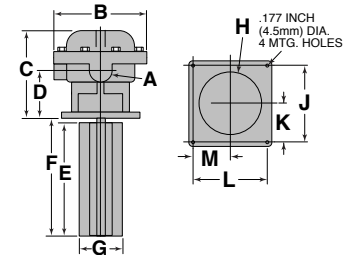

Electrical Ratings

Voltage	Motor Switch Rating (Amperes)		Pilot Duty
	Full Load	Locked Rotor	
120 VAC	7.4	44.4	125 VA at 120 or 240 VAC 50 or 60 cycles
240 VAC	3.7	22.2	

Ordering Information

Model Number	Part Number	Description	Weight lbs. (kg)
AFE-1	123010	Air flow switch w/NEMA 7 & 9 enclosure 6	(2.7)

Flow Rates – feet per minute (meters per minute)

Horizontal Duct (Recommended Installation)

Mounting/Duct	Settings	Mode of Operation	
		Flow fpm (mpm)	No Flow fpm (mpm)
Top (Recommended)	Factory or Minimum	300 (91)	100 (30)
	Maximum	1900 (579)	500 (152)
Side	Factory or Minimum	350 (107)	100 (30)
	Maximum	1950 (594)	900 (274)

Based on Standard Air 0.075 pounds per Cubic Foot (1.205 kg/m³)
Values are ± 10%

Dimensions, in. (mm)

A	B	C	D	E	F
½ NPT	5¾ (146)	5 ¹³ / ₃₂ (137.3)	2 ²⁹ / ₃₂ (74)	7 ¹ / ₈ (181)	7 ¹ / ₂ (191)
G	H	J	K	L	M
2¾ (70)	3 ⁵ / ₈ (92)	4 ³ / ₈ (111)	2 ³ / ₁₆ (56)	4 ³ / ₈ (111)	2 ¹³ / ₁₆ (56)

Flow Switches – Air

Series AF2 Air Flow Switches

- For low velocity applications
- Paddle fits 8" (203mm) minimum duct size
- Two electrical knock-outs allow connection from either end
- Brass, steel and aluminum construction
- Single pole, double throw snap switch
- Sensitivity adjusting screw makes flow adjustment easy
- Can be equipped with a time delay relay
- Minimum ambient temperature 32°F (0°C)
- Maximum duct temperature 300°F (149°C)

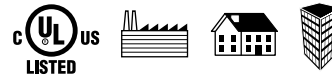

Series AF2

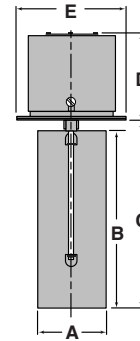

Electrical Ratings

Voltage	Motor Switch Rating (Amperes)		Pilot Duty
	Full Load	Locked Rotor	
120 VAC	7.4	44.4	125 VA at 120 or 240 VAC 50 or 60 cycles
240 VAC	3.7	22.2	

Dimensions, in. (mm)

A	B	C	D	E
2 ³ / ₄ (70)	7 ¹ / ₄ (184)	7 ²¹ / ₃₂ (194)	3 ⁷ / ₁₆ (87)	4 ³ / ₈ (111)

Flow Rates – feet per minute (meters per minute) using standard paddle

Horizontal Duct

Settings	Mode of Operation	
	Flow fpm (mpm)	No Flow fpm (mpm)
Factory or Minimum	380 (115)	210 (63)
Maximum	1250 (380)	1000 (304)

Based on Standard Air 0.075 pounds per Cubic Foot (1.205 kg/m³)
Values are ± 10%

Ordering Information

Model Number	Part Number	Description	Weight lbs. (kg)
AF2	123200	Air flow switch - low velocity	2.0 (.9)

Flow Switches – Air

Series AF3 Air Flow Switches

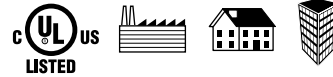

- For general purpose low velocity applications where the most economical flow switch is desired
- Paddle fits 8" (203mm) minimum duct size
- Two electrical knock-outs allow connection from either end
- Brass, steel and aluminum construction
- Single pole, double throw snap switch
- Sensitivity adjusting screw makes flow adjustment easy
- Can be equipped with a time delay relay
- Optional feature
 - Two SPDT snap switches
- Minimum ambient temperature 32°F (0°C)
- Maximum duct temperature 275°F (135°C)



Series AF3

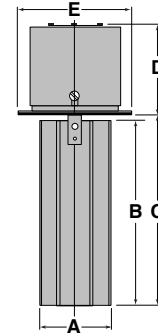

Electrical Ratings

Voltage	Motor Switch Rating (Amperes)		Pilot Duty
	Full Load	Locked Rotor	
120 VAC	7.4	44.4	125 VA at 120 or 240 VAC 50 or 60 cycles
240 VAC	3.7	22.2	

Dimensions, in. (mm)

A	B	C	D	E
2 ³ / ₄ (70)	7 ¹ / ₈ (181)	7 ¹¹ / ₃₂ (186.5)	3 ⁷ / ₁₆ (87)	4 ³ / ₈ (111)

Ordering Information

Model Number	Part Number	Description	Weight lbs. (kg)
AF3	123400	Air flow switch - medium velocity	1.7 (.8)
AF3-D	123450	AF3 w/2 SPDT switches	2.0 (.9)

Flow Rates – feet per minute (meters per minute) using standard paddle

Horizontal Duct (Recommended Installation)

Model Number	Settings	Mode of Operation	
		Flow fpm (mpm)	No Flow fpm (mpm)
AF3	Factory or Minimum	235 (72)	175 (53)
	Maximum	1445 (440)	1365 (416)
AF3-D	Factory or Minimum	295 (90)	220 (67)
	Maximum	1445 (440)	1000 (305)

Based on Standard Air 0.075 pounds per Cubic Foot (1.205 kg/m³)
Values are ± 10%

Vertical Duct (Upward Flow)

Model Number	Settings	Mode of Operation	
		Flow fpm (mpm)	No Flow fpm (mpm)
AF3	Factory or Minimum	450 (137)	430 (131)
	Maximum	1470 (448)	1395 (425)
AF3-D	Factory or Minimum	560 (171)	540 (165)
	Maximum	1470 (448)	1030 (314)

Based on Standard Air 0.075 pounds per Cubic Foot (1.205 kg/m³)
Values are ± 10%

Types of Electrical Switches

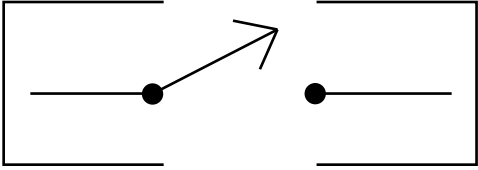
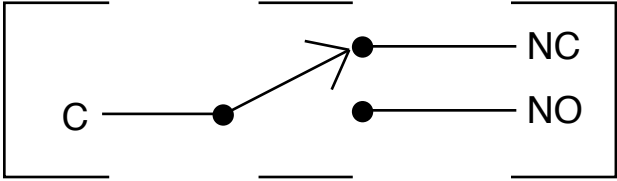
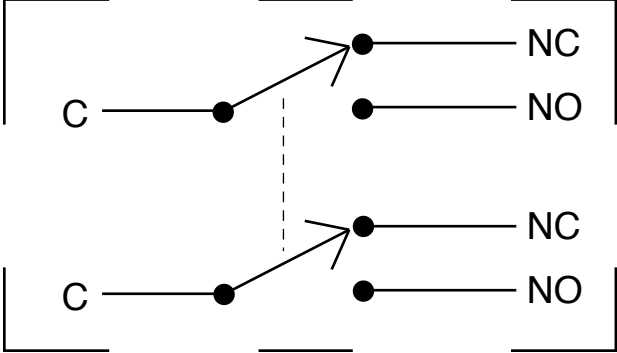
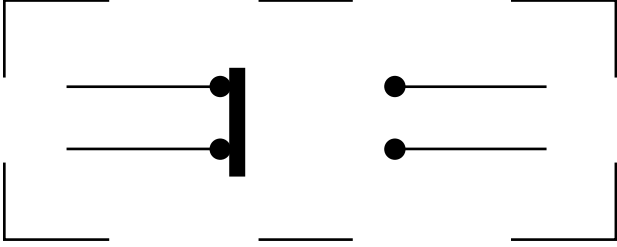
Type	Description	Where Used
 <p style="text-align: center;">SPST (Single Pole, Single Throw)</p>	Make or break one circuit.	Series 150S boiler control pump switch Series 11 switch
 <p style="text-align: center;">SPDT (Single Pole, Double Throw)</p>	Make one circuit and break one circuit with common terminal.	Series 2 switch Series 150S boiler control burner switch & alarm All flow switches Series 150E pump & burner switches
 <p style="text-align: center;">DPDT (Double Pole, Double Throw)</p>	Make two circuits and break two circuits with two common terminals.	Series FS7-4D flow switch Series FS4-3D flow switch Series AF3-D flow switch Series FS5-D flow switch
 <p style="text-align: center;">SPDB (Single Pole, Double Break)</p>	Make one circuit and break one circuit with no common terminals.	Series 5 switch

Switch Operation

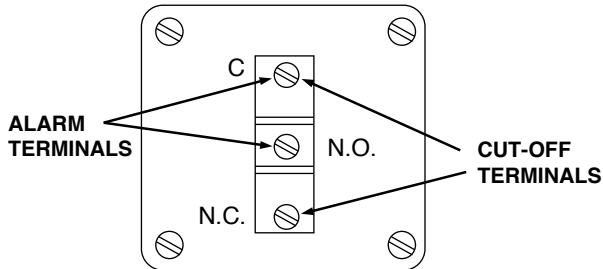

No. 2 Switch
Used on McDonnell No. 47-2,
No. 247-2, No. 51-2, No. 51-S-2,
No. 53-2 and No. 63

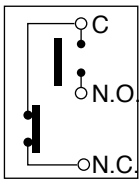

Water level normal.
Burner on—alarm off.

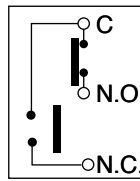

Low water level. Burner
off—alarm on.

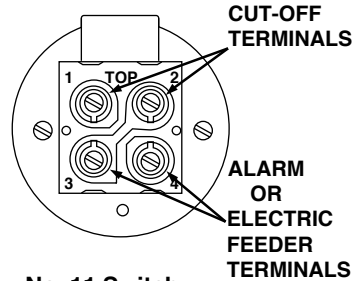

No. 11 Switch
Used on McDonnell No. 64,
No. 67, No. 61 and all "Built-
in" type Low Water Cut-offs.

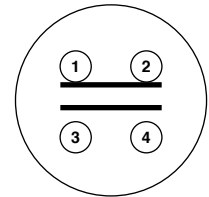

Water level normal.
Burner on—electric
feed valve or alarm
off.

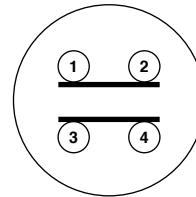

Water level dropped to
electric feed valve or alarm
operating level. Burner on.

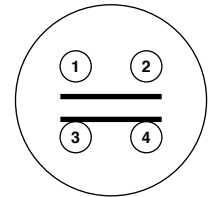

Low water level.
Burner off—electric
feed valve or alarm
on.

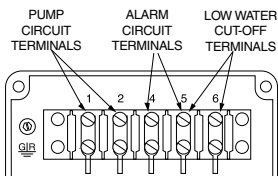

Series 150S Switch
Used on No. 150S and 157S
Series.

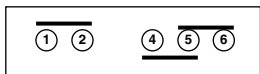

At Normal Operating Level
Boiler feed pump off—burner
on—alarm off.

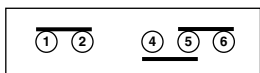

As Water Level Drops
Boiler feed pump on—burner
on—alarm off.

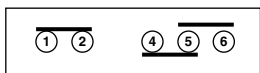

At Low Water Cut-Off Level
Boiler feed pump on—burner
off—alarm on.

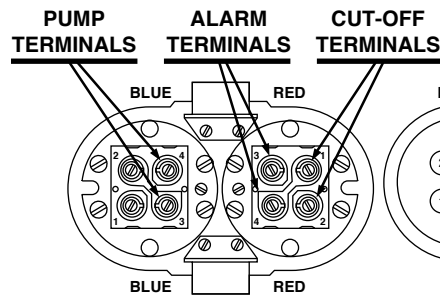

No. 5 Switch
Used on 93, 193, 94 and
194 Series.

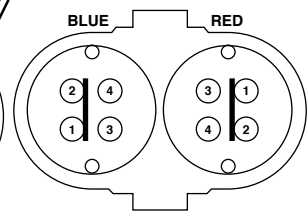

At Normal Operating Level
Boiler feed pump off—
burner on—alarm off.

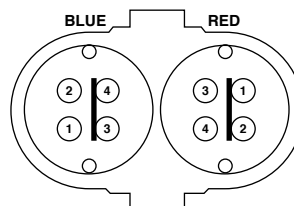

Boiler feed pump
on—burner on—alarm off.

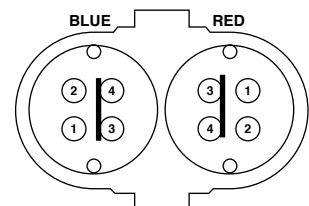

At Low Water Cut-Off Level
Boiler feed pump on—burner
off—alarm on.

The definitions given in this section are only those that apply to heating and as referenced in this catalog. It is realized that some do not define the terms for all usages, but in the interest of clearance and space this sacrifice was made.

Absolute Pressure

Actual pressure above zero, which is the atmospheric pressure added to the gauge pressure. It is expressed as a unit pressure such as lbs. per sq. in. absolute.

Atmospheric Pressure

The weight of a column of air, one square inch in cross section and extending from the earth to the upper level of the blanket of air surrounding the earth. This air exerts a pressure of 14.7 pounds per square inch at sea level, where water will boil at 212 degrees F. High altitudes have lower atmospheric pressure with correspondingly lower boiler point temperatures.

Blow Down Valve

Also referred to as a blowoff valve. A valve which permits a boiler control to be flushed out, and the function of same to be checked.

Boiler

A closed vessel in which steam is generated or in which water is heated by fire or electricity.

Boiler Crown

The part of a boiler which forms the top of the furnace in a fire box boiler, or the equivalent surface in other types of boilers.

Boiler Feed Pump

A pump that is governed by a control that monitors the actual boiler water level; and only adds water to the boiler when the boiler needs it. The pump controller is mounted on the boiler.

Boiler Heating Surface

The area of the heat transmitting surfaces in contact with the water (or steam) in the boiler on one side and the fire or hot gases on the other.

Boiler Horse Power

The equivalent evaporation of 34.5 lbs of water per hour at 212 degrees F to steam at 212 degrees F. This is equal to a heat output of 33,475 BTU per hour, which is equal to approximately 140 sq. ft. of steam radiation (EDR).

British Thermal Unit (BTU)

The quantity of heat required to raise the temperature of 1 lb. of water 1 degree F. This is somewhat approximate but sufficiently accurate for any work discussed in this catalog.

BSPT

British Standard Pipe Thread

Built-Ins

A float-type control that screws directly into the boiler, such as the Series 69 and Series 70 low water cutoffs.

Condensate

In steam heating, the water formed by cooling steam as in a radiator. The capacity of traps, pumps, etc., is sometimes expressed in lbs. of condensate they will handle per hour. One pound of condensate per hour is equal to approximately 4 sq. ft. of steam heating surface (240 BTU per hour per sq. ft.).

Condensate Pump

A pump that is controlled by a switch mounted on the condensate tank. It adds water to the boiler when the condensate tank becomes full, whether the boiler needs water or not.

Dry Fire

Insufficient water in a boiler to carry off the heat of combustion. It causes dry fire which results in cracked cast iron sections, and melted fire tubes.

Dry Saturated Steam

Saturated steam containing no water in suspension.

EDR – (Equivalent Direct Radiation)

The amount of heating surface that will give off 240 BTU per hour when filled with a liquid that is heated to 215°F and surrounded by 70°F air. It may not have a direct relation to the actual surface area.

Fire Tube Boiler

This type of boiler has the water on the external side of the tube and the heat (fire) on the internal side of the tube.

Flash (Steam)

The rapid passing into steam of water at a high temperature when the pressure it is under is reduced so that its temperature is above that of its boiling point for the reduced pressure. For example: if hot condensate is discharged by a trap into a low pressure return or into the atmosphere, a certain percentage of the water will be immediately transformed into steam. It is also called re-evaporation.

Foaming

A condition that occurs when an organic substance, usually oil, is floating on the surface of the water in a boiler. When the boiler is fired, a layer of foam develops on the surface of the water. This generally is indicated in the gauge glass by large swings in water level.

Freeze Up

This refers to a structure that has lost its heating system, and the water in the piping freezes.

Furnace

That part of a boiler or warm air heating plant in which combustion takes place. Sometimes also the complete heating unit of a warm air heating system.

Gauge Glass

Sometimes called water glass or sight glass. It is a device that gives a visual means of the water level in a boiler. By code, all steam boilers are required to have one.

Head

Unit pressure usually expressed ft. of water or mil-inches of water.

Heat

That form of energy into which all other forms may be changed. Heat always flows from a body of higher temperature to a body of lower temperature. *See also: Latent Heat, Sensible Heat, Specific Heat, Total Heat, Heat of the Liquid.*

Heat of the Liquid

The heat (BTU) contained in a liquid due to its temperature. The heat of the liquid for water is zero at 32 degrees F, and increases 1 BTU: approximately for every degree rise in temperature.

Heat Unit

In the foot-pound-second system, the British Thermal Unit (BTU).

Heating Medium

A substance such as water, steam, or air used to convey heat from the boiler, furnace, or other source of heat to the heating units from which the heat is dissipated.

Hot Water Heating System

A heating system in which water is used as the medium by which heat is carried through pipes from the boiler to the heating units.

Latent Heat of Evaporation

The heat (BTU of pound) necessary to change 1 pound of liquid into vapor without raising its temperature. In round numbers, this is equal to 960 BTU per pound of water.

Low Pressure Steam

As defined by ASME, low pressure steam is 15 PSIG or less.

Make-Up Water

Fresh water added to the system, by various means, to replace normal and abnormal water losses.

Manual Reset

A control that has to have human input before the burner will come back on after a low water condition.

Maximum Differential (MD)

A control with this designation has a greater spread between pump on and burner off.

Minimum Safe Water Level

Also known as the minimum safe operating level. The minimum level of water in a boiler where the burner will still operate. Below this level, the burner should be off due to low water.

NPT

National Pipe Thread.

Overfiring

A situation where the burner does not turn off, for a number of reasons. The pressure of the system rises and the safety relief valve opens.

Pilot Valve

A valve that uses a small valve to control a large valve.

Pressure

Force per unit area such lb. per sq. inch.

Pressure Reducing Valve

A piece of equipment for changing the pressure of a gas or liquid from a higher to a lower one.

Priming

When the steam leaving the boiler carries large amounts of water with it, this is called priming. Insufficient heat, water hammer, and a flooded boiler, if the system has an automatic water feeder are some of the symptoms. It is generally caused by a high water level in the boiler, and near boiler piping.

Radiator

A heating unit located within the room to be heated and exposed to view. A radiator transfers heat by radiation to objects "it can see" and by conduction to the surrounding air which in turn is circulated by natural convection.

Sensible Heat

Heat which only increases the temperature of objects as opposed to latent heat.

Skimming

A procedure for cleaning the surface of the water in a boiler. This procedure should be done on all new boiler installations, and when there is a foaming condition.

Steam

Water in the vapor phase. The vapor formed when water has been heated to its boiling point, corresponding to the pressure it is under. *See also Dry Saturated Steam, Wet Saturated Steam, Super Heated Steam*

Steam Heating System

A heating system in which the heating units give up their heat to the room by condensing the steam furnished to them by a boiler or other source.

Steam Pop Safety Valve (Relief Valve)

A device to prevent over pressure in a boiler. It should be set for 15 psi on low pressure steam boilers. On high pressure boilers, it should be set at the maximum working pressure of the boiler, or lower if the boiler is not going to be operated at its maximum pressure.

Steam Trap

A device for allowing the passage of condensate and air but preventing the passage of steam.

Supply Mains

The pipes through which the heating medium flows from the boiler or source of supply to the run-outs and riser leading to the heating units.

Two-Pipe System (Steam or Water)

A heating system in which one pipe is used for the supply main and another for the return main. The essential feature of a two-pipe hot water system is that each heating unit receives a direct supply of the heating medium which cannot have served a preceding heating unit.

Tube Bundle

A single tube (pipe) formed into a tight array so as to present a large surface area in a small space.

Vacuum Heating System (Steam)

A one or two-pipe heating system equipped with the necessary accessory apparatus to permit the pressure in the system to go below atmospheric.

Vapor

Any substance in the gaseous state.

Vapor Heating System (Steam)

A two-pipe heating system which operates under pressure at or near atmospheric and which returns the condensation to the boiler or receiver by gravity.

Vent Valve (Steam)

A device for permitting air to be forced out of a heating unit or pipe and which closes against water and steam.

Vent Valve (Water)

A device permitting air to be pushed out of a pipe or heating unit but which closes against water.

Water Tube Boilers

This type of boiler has the water circulated through a tube bundle with the heat applied on the external side of the tube.

Wet Return (Steam)

That part of a return main of a steam heating system which is completely filled with water of condensation.

Approval Agencies



Underwriters Laboratories Listed
This product has been UL Listed.



Factory Mutual

This product is approved for used in an “accepted” system installation. Such installations where the product falls into one of the following categories:

- Is used for the control or prevention of property damage.
- Those items that are improperly designed would pose serious hazards.



Underwriters Laboratories Listed – Canada and the United States
This product has been UL Listed.



Canadian Standards Association
This product meets or exceeds the Canadian Standards Association requirements.



Underwriters Laboratories Recognized Component – Canada and the United States

This product has been UL Recognized.

AGENCY LISTINGS

Underwriters Laboratories

File	UL Category Code	Description	M&M Products
MP918	MBPR	CONTROLS, LIMIT	750, 751P, 752P, PS Series, PSE Series, RB Series, 42S, 150S, 93, 94, 61, 63, 64, 67,69, 47, 247, 51, 51-S, 53, WFE, 1575, RS Series
MP918	MBPR2	CONTROLS, LIMIT - COMPONENT	PA Series, 750B-C3/4
MP918	MBPR7	CONTROLS, LIMIT - CANADA	750, 751P, 752P, PS Series, PSE Series, RB-Series, WFE
MP918	MBPR8	CONTROLS, LIMIT - COMPONENT - CANADA	PA Series, 750B-C3/4
MH2725	MFHX	SWITCHES	AF Series, FS1 Series, FS4 Series, FS5 Series, FS6 Series, FS7 Series, FS8 Series, FS-250 Series
MH2725	MFHX7	SWITCHES - CANADA	AF Series, FS1 Series, FS4 Series, FS5 Series, FS6 Series, FS7 Series, FS8 Series, FS-250 Series
MH16430	MJAT	SPECIALTY, HEATING AND HEATING-COOLING APPLIANCE ACCESSORIES	TC-4
MH16430	MJAT7	SPECIALTY, HEATING AND HEATING-COOLING APPLIANCE ACCESSORIES - CANADA	TC-4
E33646	NMFT	MOTOR CONTROLLERS, MISCELLANEOUS	FS7-4, FS7-4W
E33646	NMFT7	MOTOR CONTROLLERS, MISCELLANEOUS - CANADA	FS7-4, FS7-4W
E33552	NQLX	MISCELLANEOUS MOTOR CONTROLLERS, FOR USE IN HAZARDOUS LOCATIONS	FS7-4E, AFE-1
E33552	NQLX7	MISCELLANEOUS MOTOR CONTROLLERS, FOR USE IN HAZARDOUS LOCATIONS - CANADA	FS7-4E
MP1197	YIOZ	VALVES, ELECTRICALLY OPERATED	101A

Canadian Standards Association

File	CSA Class Code	Description	M&M Products
5545	3211-07	INDUSTRIAL CONTROL EQUIPMENT	42S, 150S, 93, 94, 61, 63, 64, 67, 69, 47, 247, 51, 51S, 53, 101A, 1575, 750B-C3/4

IMPORTANT

- Previously used controls should never be installed on a new system. Always install new controls on a new boiler or system.
- A more frequent replacement interval may be necessary based on the condition of the unit at time of inspection. McDonnell & Miller's warranty is one (1) year from date of installation or two (2) years from the date of manufacture.
- Visually inspect the inside of the float chamber during the annual inspection. Partial disassembly may be required.

Inspect all controls annually, and replace, repair or clean, as needed. All chambered units are to be blown down per manufacturers instructions and local code requirements. These requirements are to be determined by the local service company, and are based on water quality and system operation variables.

Refer to the installation instructions provided with the product for specific assembly and test procedures.

McDonnell & Miller products must also be maintained in accordance with the following ASME Code.

ASME Boiler and Pressure Vessel Code – Section VI Paragraph 7.07 G

Low-Water Fuel Cut-Off and Water Feeder Maintenance. Low-water fuel cut-offs and water feeders should be dismantled annually, by qualified personnel, to the extent necessary to insure freedom from obstructions and proper functioning of the working parts. Inspect connecting lines to boiler for accumulation of mud, scale, etc., and clean as required. Examine all visible wiring for brittle or worn insulation and make sure electrical contacts are clean and that they function properly. Give

special attention to solder joints on bellows and float when this type of control is used. Check float for evidence of collapse and check mercury bulb (where applicable) for mercury separation or discoloration. Do not attempt to repair mechanisms in the field. Complete replacement mechanisms, including necessary gaskets and installation instructions are available from the manufacturer. After reassembly, test as per 7.05H.

McDonnell & Miller controls manufactured after 1972 feature a stamped date code, so you can easily check the life expectancy and recommended replacement intervals. **If a control has no date stamp or does not have a logo on it – replace it!**

See the chart (next page) for more specific information on maintenance and replacement intervals. Below are guides to help you quickly locate and translate the date code on McDonnell & Miller controls.

WHERE TO FIND



McDonnell & Miller
a xylem brand

DATE CODES

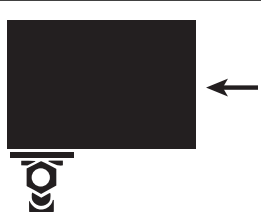
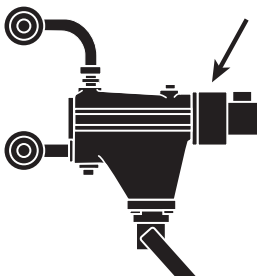
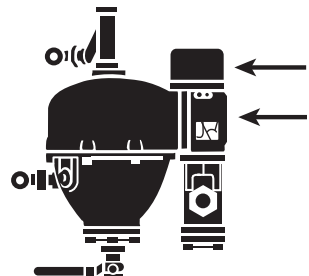

McDonnell & Miller
a xylem brand

Product Date Code Translation

Month	Year	Example
A = January	W = 1979 X = 1980 Y = 1981	K09 Translates to October 1990
B = February	Z = 1982 38 = 1983 48 = 1984 58 = 1985 68 = 1986 78 = 1987 88 = 1988 98 = 1989	
C = March	09 = 1990 19 = 1991 29 = 1992 39 = 1993 49 = 1994 59 = 1995	
D = April		
E = May		
F = June		
G = July		
H = August		
J = September		
K = October		
L = November	96 = 1996 97 = 1997 98 = 1998 99 = 1999 00 = 2000 01 = 2001 02 = 2002 03 = 2003 04 = 2004 05 = 2005 06 = 2006 07 = 2007 08 = 2008	Between 1996 and 2008 the month designator preceeds year 96K equals October 1996
M = December	09 = 2009 01 = 2010 11 = 2011 21 = 2012 31 = 2013 41 = 2014 51 = 2015 61 = 2016 71 = 2017 81 = 2018 91 = 2019 02 = 2020 12 = 2021 22 = 2022 32 = 2023 42 = 2024 52 = 2025 62 = 2026 72 = 2027 82 = 2028 92 = 2029 03 = 2030	Beginning in 2009 the month designator preceeds the year and the year is reversed K61 equals October 2016

Recommended Replacement Intervals

Product	Series	Recommended Maintenance	Recommended Replacement Interval (Maximum)
Low Water Cut-Offs	1575, 150S, 157S, 158S, 159S	Blow down and test daily inspect annually.	15 years
	69, 169, 269, 369, 469	Inspect and test annually.	10 years
	67, 767	Blow down weekly. Inspect and test annually.	10 years
	61, 63, 64, 764	Blow down weekly. Inspect and test annually.	10 years
	42S	Blow down daily. Inspect and test annually.	10 years
	93, 94, 193, 194	Blow down and test daily. Inspect and test annually.	15 years
	750, 751P/752P, PSE-800, RB-122E	Inspect and test annually.	15 years
	RB-24	Inspect and test annually.	10 years
Water Feeders	WFE/Uni-Match®	Inspect and test annually. Replace filter annually.	10 years
	101-A	Inspect, test, and replace cartridge valve annually.	10 years
	21, 221, 25-A, 51-S, 53, 851-S, 3155	Inspect and test annually. Blow down weekly.	15 years
	101-A, 47, 51, 247, 847, 551-S, 851	Blow down weekly. Inspect and replace cartridge valve annually.	10 years
Liquid Level Controls	PFC	Inspect and test annually. Blow down weekly.	15 years
	27-W	Inspect and test annually.	5 years
Replacement Blow Down Valves	14-B	Inspect and test annually.	10 years
	14	Replace with 14-B blow down valve.	3 years
Replacement Probes	751P/752P, PSE-800, RB-122E	Self cleaning probes. inspect 5 yrs.	10 years
Replacement Head Mechanisms for Commercial/Industrial Applications	25-A, 42, 42S, 51, 51-S, 53, 61, 63, 64, 67, 93, 94, 150, 150S, 150E, 157, 157S, 193, 194	Inspect and test annually.	5 years
Flow Switches	FS1, FS4-3, FS5 FS43T, FS6, FS7-4 FS8W, AF, FS-250	Inspect and test annually.	10 years

Commercial Warranty

Warranty. For goods sold to commercial buyers, Seller warrants the goods sold to Buyer hereunder (with the exception of membranes, seals, gaskets, elastomer materials, coatings and other “wear parts” or consumables all of which are not warranted except as otherwise provided in the quotation or sales form) will be (i) be built in accordance with the specifications referred to in the quotation or sales form, if such specifications are expressly made a part of this Agreement, and (ii) free from defects in material and workmanship for a period of one (1) year from the date of installation or two (2) years from the date of manufacture, whichever shall occur first, unless a longer period is specified in the product documentation (the “Warranty”).

Except as otherwise required by law, Seller shall, at its option and at no cost to Buyer, either repair or replace any product which fails to conform with the Warranty provided Buyer gives written notice to Seller of any defects in material or workmanship within ten (10) days of the date when any defects or non-conformance are first manifest. Under either repair or replacement option, Seller shall not be obligated to remove or pay for the removal of the defective product or install or pay for the installation of the replaced or repaired product and Buyer shall be responsible for all other costs, including, but not limited to, service costs, shipping fees and expenses. Seller shall have sole discretion as to the method or means of repair or replacement. Buyer's failure to comply with Seller's repair or replacement directions shall terminate Seller's obligations under this Warranty and render the Warranty void. Any parts repaired or replaced under the Warranty are warranted only for the balance of the warranty period on the parts that were repaired or replaced. Seller shall have no warranty obligations to Buyer with respect to any product or parts of a product that have been: (a) repaired by third parties other than Seller or without Seller's written approval; (b) subject to misuse, misapplication, neglect, alteration, accident, or physical damage; (c) used in a manner contrary to Seller's instructions for installation, operation and maintenance; (d) damaged from ordinary wear and tear, corrosion, or chemical attack; (e) damaged due to abnormal conditions, vibration, failure to properly prime, or operation without flow; (f) damaged due to a defective power supply or improper electrical protection; or (g) damaged resulting from the use of accessory equipment not sold or approved by Seller. In any case of products not manufactured by Seller, there is no warranty from Seller; however, Seller will extend to Buyer any warranty received from Seller's supplier of such products.

THE FOREGOING WARRANTY IS EXCLUSIVE AND IN LIEU OF ANY AND ALL OTHER EXPRESS OR IMPLIED WARRANTIES, GUARANTEES, CONDITIONS OR TERMS OF WHATEVER NATURE RELATING TO THE GOODS PROVIDED HEREUNDER, INCLUDING WITHOUT LIMITATION ANY IMPLIED WARRANTIES OF MERCHANTABILITY AND FITNESS FOR A PARTICULAR PURPOSE, WHICH ARE HEREBY EXPRESSLY DISCLAIMED AND EXCLUDED. EXCEPT AS OTHERWISE REQUIRED BY LAW, BUYER'S EXCLUSIVE REMEDY AND SELLER'S AGGREGATE LIABILITY FOR BREACH OF ANY OF THE FOREGOING WARRANTIES ARE LIMITED TO REPAIRING OR REPLACING THE PRODUCT AND SHALL IN ALL CASES BE LIMITED TO THE AMOUNT PAID BY THE BUYER FOR THE DEFECTIVE PRODUCT. IN NO EVENT SHALL SELLER BE LIABLE FOR ANY OTHER FORM OF DAMAGES, WHETHER DIRECT, INDIRECT, LIQUIDATED, INCIDENTAL, CONSEQUENTIAL, PUNITIVE, EXEMPLARY OR SPECIAL DAMAGES, INCLUDING BUT NOT LIMITED TO LOSS OF PROFIT, LOSS OF ANTICIPATED SAVINGS OR REVENUE, LOSS OF INCOME, LOSS OF BUSINESS, LOSS OF PRODUCTION, LOSS OF OPPORTUNITY OR LOSS OF REPUTATION.

LIMITED CONSUMER WARRANTY

Warranty. For goods sold for personal, family or household purposes, Seller warrants the goods purchased hereunder (with the exception of membranes, seals, gaskets, elastomer materials, coatings and other “wear parts” or consumables all of which are not warranted except as otherwise provided in the quotation or sales form) will be free from defects in material and workmanship for a period of one (1) year from the date of installation or two (2) years from the product date code, whichever shall occur first, unless a longer period is provided by law or is specified in the product documentation (the “Warranty”).

Except as otherwise required by law, Seller shall, at its option and at no cost to Buyer, either repair or replace any product which fails to conform with the Warranty provided Buyer gives written notice to Seller of any defects in material or workmanship within ten (10) days of the date when any defects or non-conformance are first manifest. Under either repair or replacement option, Seller shall not be obligated to remove or pay for the removal of the defective product or install or pay for the installation of the replaced or repaired product and Buyer shall be responsible for all other costs, including, but not limited to, service costs, shipping fees and expenses. Seller shall have sole discretion as to the method or means of repair or replacement. Buyer's failure to comply with Seller's repair or replacement directions shall terminate Seller's obligations under this Warranty and render this Warranty void. Any parts repaired or replaced under the Warranty are warranted only for the balance of the warranty period on the parts that were repaired or replaced. The Warranty is conditioned on Buyer giving written notice to Seller of any defects in material or workmanship of warranted goods within ten (10) days of the date when any defects are first manifest.

Seller shall have no warranty obligations to Buyer with respect to any product or parts of a product that have been: (a) repaired by third parties other than Seller or without Seller's written approval; (b) subject to misuse, misapplication, neglect, alteration, accident, or physical damage; (c) used in a manner contrary to Seller's instructions for installation, operation and maintenance; (d) damaged from ordinary wear and tear, corrosion, or chemical attack; (e) damaged due to abnormal conditions, vibration, failure to properly prime, or operation without flow; (f) damaged due to a defective power supply or improper electrical protection; or (g) damaged resulting from the use of accessory equipment not sold or approved by Seller. In any case of products not manufactured by Seller, there is no warranty from Seller; however, Seller will extend to Buyer any warranty received from Seller's supplier of such products.

THE FOREGOING WARRANTY IS PROVIDED IN PLACE OF ALL OTHER EXPRESS WARRANTIES. ALL IMPLIED WARRANTIES, INCLUDING BUT NOT LIMITED TO THE IMPLIED WARRANTIES OF MERCHANTABILITY AND FITNESS FOR A PARTICULAR PURPOSE, ARE LIMITED TO ONE (1) YEAR FROM THE DATE OF INSTALLATION OR TWO (2) YEARS FROM THE PRODUCT DATE CODE, WHICHEVER SHALL OCCUR FIRST. EXCEPT AS OTHERWISE REQUIRED BY LAW, BUYER'S EXCLUSIVE REMEDY AND SELLER'S AGGREGATE LIABILITY FOR BREACH OF ANY OF THE FOREGOING WARRANTIES ARE LIMITED TO REPAIRING OR REPLACING THE PRODUCT AND SHALL IN ALL CASES BE LIMITED TO THE AMOUNT PAID BY THE BUYER FOR THE DEFECTIVE PRODUCT. IN NO EVENT SHALL SELLER BE LIABLE FOR ANY OTHER FORM OF DAMAGES, WHETHER DIRECT, INDIRECT, LIQUIDATED, INCIDENTAL, CONSEQUENTIAL, PUNITIVE, EXEMPLARY OR SPECIAL DAMAGES, INCLUDING BUT NOT LIMITED TO LOSS OF PROFIT, LOSS OF ANTICIPATED SAVINGS OR REVENUE, LOSS OF INCOME, LOSS OF BUSINESS, LOSS OF PRODUCTION, LOSS OF OPPORTUNITY OR LOSS OF REPUTATION.

Some states do not allow limitations on how long an implied warranty lasts, so the above limitation may not apply to you. Some states do not allow the exclusion or limitation of incidental or consequential damages, so the above exclusions may not apply to you. This warranty gives you specific legal rights, and you may also have other rights which may vary from state to state.

To make a warranty claim, check first with the dealer from whom you purchased the product or call +1-847-966-3700 for the name and location of the nearest dealer providing warranty service.

Return Goods Policy

Unused material may be returned for credit only with the written or oral consent of McDonnell & Miller. This consent is in the form of an RGA number issued by McDonnell & Miller, and is subject to the following conditions.

1. Materials must be unused, of current design, and in original cartons.
2. Credit will be issued based upon either a referenced invoice or product date code if an invoice is not referenced. Requester is to supply copy of the referenced invoice if requested.
3. A 25% restocking charge will apply.
4. Unauthorized material returned to McDonnell & Miller will be either refused or sent back to the sender freight collect by a carrier chosen by McDonnell & Miller.
5. If material is received but subsequently found not to have met the above conditions, it will be sent back to the sender freight collect by a carrier chosen by McDonnell & Miller.
6. Products which are obsolete or made to special order are not returnable.

Xylem |'zīləm|

- 1) The tissue in plants that brings water upward from the roots;
- 2) a leading global water technology company.

We're a global team unified in a common purpose: creating advanced technology solutions to the world's water challenges. Developing new technologies that will improve the way water is used, conserved, and re-used in the future is central to our work. Our products and services move, treat, analyze, monitor and return water to the environment, in public utility, industrial, residential and commercial building services settings. Xylem also provides a leading portfolio of smart metering, network technologies and advanced analytics solutions for water, electric and gas utilities. In more than 150 countries, we have strong, long-standing relationships with customers who know us for our powerful combination of leading product brands and applications expertise with a strong focus on developing comprehensive, sustainable solutions.

For more information on how Xylem can help you, go to www.xylem.com

The Little Red Schoolhouse® - Training the Industry



Seminars currently offered are:

- Modern Hydronic System Design - Basic*
- Modern Hydronic System Design - Advanced*
- Design & Application of Water Based HVAC Systems
- Large Chilled Water System Design*
- Pump Service & Maintenance School
- Steam Systems Design & Applications
- Steam System Operation & Maintenance
- Plumbing Systems Design

Bell & Gossett has long been known for its dedication to training. The "Little Red Schoolhouse®" has graduated over 60,000 students since it was founded in 1954.

Graduates from the "Little Red Schoolhouse" may be found throughout North America, Europe, Africa, Asia and Australia.

For applications to attend these seminars, please contact a Bell & Gossett Representative in your area. They will have the schedule dates for all seminars and will make all the arrangements for you. As a service and a continuing educational source to the HVAC industry, these seminars are offered free of charge. IACET certified CEU credits are awarded for each seminar.

* The USGBC has approved the technical and instructional quality of the Modern Hydronic Heating Systems - Basic Seminar (15 GBCI CE Hours) and the Large Chilled Water Design Seminar (11 GBCI CE Hours). These courses are approved for GBCI Continuing Education Hours towards LEED Credential Maintenance Programs.



Xylem Inc.
8200 N. Austin Avenue
Morton Grove, Illinois 60053
Phone: (847) 966-3700
Fax: (847) 965-8379
www.xylem.com/mcdonnellmiller

McDonnell & Miller is a trademark of Xylem Inc. or one of its subsidiaries.
© 2020 Xylem Inc. MM-825M March 2020